



AC NO: 70/7460-1A

DATE: 1 Jan 72

ADVISORY CIRCULAR

DEPARTMENT OF TRANSPORTATION
FEDERAL AVIATION ADMINISTRATION

SUBJECT: OBSTRUCTION MARKING AND LIGHTING

1. PURPOSE. This advisory circular describes the FAA standards on obstruction marking and lighting and establishes the methods, procedures and equipment types for both aviation red and high intensity white obstruction lights.
2. CANCELLATION. This circular cancels and supersedes Advisory Circular No. 70/7460-1 dated February 1968.
3. EXPLANATION OF REVISIONS. The standards have been amended to include lighting with high intensity white lights for daytime marking in lieu of painting on smokestacks and similar structures; however, this is not applicable to skeletal type structures.
4. HOW TO OBTAIN THIS CIRCULAR. Obtain copies of this Advisory Circular 70/7460-1A, Obstruction Marking and Lighting, free of charge from the Department of Transportation, Distribution Unit, TAD 484.3, Washington, D. C. 20590.

William M. Flener

William M. Flener, Director
Air Traffic Service

TABLE OF CONTENTS

	<u>Page No.</u>
CHAPTER 1. INTRODUCTION	1
1. Purpose	1
2. Objective	1
3. Federal Communications Commission Specifications	1
CHAPTER 2. GENERAL REQUIREMENTS	3
4. Application	3
5. Deviations and Modifications	3
CHAPTER 3. MARKING	5
6. Purpose	5
7. Colors	5
8. Types of Markers	5
9. Coloring	6
CHAPTER 4. LIGHTING	11
10. Purpose	11
11. Location of Lighting	11
12. Qualities of Lighting	12
13. Operation of Obstruction Lighting	14
14. Special Conditions	18
CHAPTER 5. OBSTRUCTION MARKING AND LIGHTING EQUIPMENT	21
15. Paint	21
16. Lights and Associated Equipment	21
CHAPTER 6. STANDARDS FOR LIGHTING OBSTRUCTIONS TO AIR NAVIGATION WITH AVIATION RED OBSTRUCTION LIGHTS	25
17. Purpose	25
18. Application	25
19. Specifications	26

Page No.

CHAPTER 7.	STANDARDS FOR LIGHTING OBSTRUCTIONS TO AIR NAVIGATION WITH HIGH INTENSITY WHITE OBSTRUCTION LIGHTS	39
20.	Purpose	39
21.	Application	39
22.	Specifications	40
CHAPTER 8.	STANDARDS FOR DUAL LIGHTING SYSTEMS ON OBSTRUCTIONS TO AIR NAVIGATION	44
23.	Purpose	44
24.	Application	44
25.	Specifications	44
APPENDIX I.	EXAMPLES FOR MARKING AND LIGHTING OBSTRUCTIONS	(19 Pages)

CHAPTER 1. INTRODUCTION

1. PURPOSE. This advisory circular describes the FAA standards on obstruction marking and lighting and establishes the methods, procedures and equipment types as official Federal Aviation Administration policy.
2. OBJECTIVE. The Administrator of the FAA has the statutory responsibility for promoting safety in air commerce. In the light of this responsibility the FAA describes the standards in this publication as the most effective means of indicating the presence of obstructions to pilots.
3. FEDERAL COMMUNICATIONS COMMISSION SPECIFICATIONS. The specifications for obstruction marking and lighting antenna structures, contained in Subpart C of Part 17 of the Federal Communications Commission Rules and Regulations, are identical with the standards outlined in this publication for marking obstructions with bands of aviation surface orange and white color in accordance with Chapter 3 and for lighting obstructions in accordance with Chapter 6.

CHAPTER 2. GENERAL REQUIREMENTS

4. APPLICATION.

- a. Objects to be Marked and Lighted. When any object or portion thereof, either temporary or permanent, exceeds any standard for determining obstructions set forth in Part 77 of the Federal Aviation Regulations (14 CFR 77) and/or a height of 200 feet above site level that object should be marked and lighted in accordance with the applicable standards described herein, unless an FAA aeronautical study determines that the absence of such marking and/or lighting will not impair safety to air navigation.
- b. Recommended Equipment. Recommended types of equipment and the guidelines for marking and lighting of obstructions are contained in the standards, specifications, and procedures outlined in this circular.

5. DEVIATIONS AND MODIFICATIONS. After initially determining, through application of the two basic criteria, that an object should be marked and lighted, a further determination may be made on whether the application of the marking and lighting can be modified, or a deviation from the standards be concurred in. The final determination that may result in an agency recommendation for a modified application of the marking and lighting, or a deviation from the standards must be based on an FAA finding that the recommended marking and lighting would be effective to the extent that an acceptable level of safety is achieved.

- a. Deviations. Deviations from the obstruction marking and lighting standards set forth in this publication should have the coordinated approval of the Director, Air Traffic Service. Some examples of deviations are changes in:
 - (1) Basic signals and intensity.
 - (2) Flashing rates.
 - (3) Dimensions of described color bands or rectangles.
 - (4) Colors prescribed, etc.

1 Jan 72

b. Modifications. Modified applications of the standards may be recommended when, in the opinion of the FAA regional director or his designee, conducting the study, marking and lighting in accordance with the proposed modification would provide adequate protection for air commerce. Some examples of modified applications are:

- (1) The object may be located with reference to other objects or the contour of the ground so that the specific marking and/or lighting standards need be applied to only a portion of it.
- (2) The object may be so removed from the general flow of air traffic or so conspicuous by its shape, size, or color that marking would serve no useful purpose.
- (3) The object may present such a potential hazard that marking or lighting should be provided similar to that for an object of greater height or size.
- (4) Other similar situations.

CHAPTER 3. MARKING

6. PURPOSE. The purpose of marking a structure which may be an obstruction to air commerce is to warn airmen during the hours of daylight of its presence. To accomplish this objective, it may be necessary to color such an obstruction so that it will be visible from aircraft at any normal angle of approach, or to indicate its general definition and location by use of suitable markers or flags.
7. COLORS. Maximum visibility of an obstruction by contrast in colors can best be obtained by the use of aviation surface orange and white.
8. TYPES OF MARKERS. Markers of various types should be used to mark obstructions when it has been determined that it is impracticable to mark such obstructions by painting, or it has been determined that markers should be used to provide protection for air commerce in addition to that provided by the application of aviation surface orange and white colors.
 - a. Display. Markers should be displayed on or adjacent to the obstructions in conspicuous positions so as to retain the general definition of the obstruction and should be recognizable in clear air from a distance of at least 1,000 feet in all directions from which an aircraft is likely to approach the obstruction.
 - b. Shapes. Markers should be distinctively shaped so that they are not mistaken for markers employed to convey other information, and they should be such that the hazard presented by the obstruction they mark is not increased.
 - (1) Spherical Markers. Markers displayed on overhead wires should be spherical in shape with a diameter of not less than 20 inches. They may be of another shape, provided the projection of such type of marker on any vertical surface, normal to each direction from which an aircraft is likely to approach the obstruction, will not be less than that presented by the spherical type marker described above. At least one such marker should be displayed for each 150 feet, or fraction thereof, of the overall length of the overhead line. These markers should be placed at equal intervals not more than 150 feet apart with the top of each marker not below the level of the highest wire at the point marked, and should be colored as specified by paragraph 9, COLORING. The distance between markers on overhead wires located more than 15,000 feet from the reference point of the nearest landing area may be increased to a distance of not more than 600 feet.

1 Jan 72

- (2) Flag Markers. Flags may be used to mark obstructions when it has been determined that marking such obstructions by coloring or by spherical markers is technically impracticable.
- (a) Display. The flags should be displayed around or on top of the obstruction or around its highest edge and should not increase the hazard presented by the obstruction they mark. When flags are used to mark extensive obstructions or groups of closely spaced obstructions, they should be displayed at approximately 50-foot intervals.
- (b) Shapes. The flags should be rectangular in shape and have stiffeners to keep them from drooping in calm or light wind. The flag stakes should be of such strength and height that they will support the flags free of the ground, vegetation, or nearby surfaces.
- (c) Color Patterns. Flags should be in one of the following patterns:
- 1 Solid color aviation surface orange not less than two feet on a side.
 - 2 Two triangular sections, one of aviation surface orange and the other of aviation surface white, combined to form a rectangle not less than two feet on a side.
 - 3 A checkerboard pattern of aviation surface orange and aviation surface white squares, each one foot plus or minus 10 percent on a side, combined to form a rectangle not less than three feet on a side.

9. COLORING. Paints and enamels of aviation surface orange and white have been developed for use by government agencies and private industry for marking obstructions to air navigation. Orange or white enamel or reflective paint may be used for marking provided its chromaticity and luminance factors satisfy the specifications of the Federal standard in paragraph 15.a.

- * a. General. The specifications of surface colors apply only to freshly colored surfaces. Colors used for surface markings usually change with time. While it is not feasible to require maintenance in accordance with strict mathematical limits, due diligence should be exercised to ensure that surfaces are renewed whenever the color deviates from the limits of the FAA Aviation Surface Orange Color Tolerance Chart. *
- (1) Deletion of Painting. If the smooth surface of the paint on the ladders, decks, and walkways of certain types of steel towers and similar structures presents a potential danger to maintenance personnel, such surfaces need not be painted. However, the omission of paint should be restricted to actual surfaces the painting of which will endanger maintenance personnel, and care should be taken that the overall marking effect of the painting is not reduced.
- (2) Areas Where Applied. On skeletal-type structures paint should be applied to all surfaces of all parts (both inner and outer) of the framework.
- b. Variations.
- (1) Solid. An obstruction, the projection of which on any vertical plane has both dimensions less than five feet, should be colored aviation surface orange.
- (2) Bands. Towers, poles, smokestacks and similar obstructions, as well as buildings of certain shapes and dimensions, having essentially unbroken surfaces, the projection of which on any vertical plane is five feet or more in one dimension, and is less than 15 feet in the other dimension, and any skeletal or smokestack-type obstruction having both dimensions five feet or more, should be colored to show alternate bands of aviation surface orange and white. The bands should be perpendicular to the major axis of the obstruction, with the band at each end colored aviation surface orange. The widths of the bands should be equal and the width of each band should be approximately one-seventh of the length of the major axis of the obstruction, provided that each band shall have a width of not more than 100 feet nor less than one and one-half feet.
- (a) If the structure under study is a smokestack, skeletal structure, flagpole or similar object erected on top of a building, the combined height of the object and the supporting building should be considered the overall height to determine whether obstruction marking should be applied; however, only the length of the major axis of the smokestack, skeletal structure, or flagpole in this situation would determine the width of the color bands.

1 Jan 72

- (b) Partly Shielded. If a smokestack, skeletal structure, pole or similar structure not erected on top of a building is located with reference to other objects or the contour of the ground so that marking need be applied to only a portion of it, the width of the applied bands should be determined by the length of the major axis of the complete structure and not of just the colored portion.
- (c) Minimum Number of Bands. If a recommendation is made that the colored bands should be applied to only the upper portion of a structure, at least three colored bands, of a width determined by applying the "one-seventh rule" to the length of the major axis of the structure, should be displayed on that upper portion to ensure an orange-white-orange pattern as a minimum color display.
- * (d) Deletion. If flashing white high intensity obstruction lights are installed on a smokestack for day marking, no aviation surface orange and white stripes would be required.*
- (3) Checkerboard Pattern. Water towers, grain elevators, gas holders, and similar obstructions, as well as buildings of certain shapes and dimensions, having essentially unbroken surfaces the projection of which on any vertical plane is 15 feet or more in both dimensions, should have their top and vertical surfaces colored to show a checkerboard pattern of alternate rectangles of aviation surface orange and white. If it is technically impracticable to color the roof of a building to show alternate rectangles of aviation surface orange and white, such roof may be colored aviation surface orange. The sides of the rectangles should measure not less than five feet nor more than 20 feet. The rectangles at the corners of surfaces should be colored aviation surface orange.

- * (4) Beachball Pattern. Water towers with a single circular standpipe support may be colored in the beachball striped pattern. The storage tank should be colored to show alternate stripes of aviation surface orange and white. The stripes should extend from the top center of the tank to its supporting standpipe. The width of the stripes should be equal and the width of each band at the greatest girth of the tank should be not less than five feet nor more than 15 feet. If it is desirable to paint the name of the community on the side of the tank, the stripe pattern may be broken for a sufficient distance to serve this purpose. This open area should have a maximum height of three feet.

*

c. Exceptions.

- (1) Combined Patterns. If a part of a water tower, gas holder, building, or similar obstruction consists of a skeletal-type construction, that portion of the obstruction should be colored with alternate bands of aviation surface orange and white as specified for towers, poles, smokestacks and similar obstructions. In this case, if the portion of the obstruction which is to be colored to show a checkerboard pattern of alternate rectangles of aviation surface orange and white, has any surfaces the projection of which on any vertical plane is less than 15 feet in either dimension, the alternate rectangles of aviation surface orange and white may have dimensions of less than five feet on a side, provided their dimensions remain as close as practicable to the minimum five feet specified for coloring by the checkerboard pattern.
- (2) Bands on Certain Structures. If the size and shape of water towers, grain elevators, gas holders, and similar obstructions come within the dimensions set forth under the specification for coloring by bands, or if their type of construction does not permit coloring by the checkerboard pattern described in b(3) above, then such obstructions should be colored by bands as specified for towers, poles, smokestacks, and similar obstructions. Where this method of coloring is employed, the top aviation surface orange band should be continued from the vertical surface so as to cover the entire top of the obstruction.

1 Jan 72

- (3) Spherical Shaped Structures. If a part, or all, of certain obstructions such as water towers and gas holders of spherical shape does not permit the exact application of the checkerboard pattern of coloring, then the shape of the alternate rectangles of aviation surface orange and white covering the spherical shape may be modified to fit the particular shape of the structural surface, provided the dimensions of these modified rectangles remain to the extent practicable within the dimensional limits set forth in the specifications for coloring by the checkerboard pattern.
- (4) Limited Pattern. If certain obstructions such as gas holders and grain elevators are of such large size that the application of the checkerboard pattern of coloring to the complete outer surface of the structure would be impracticable, the application of the checkerboard pattern of coloring may be limited to the upper one-third of the structure, provided the aeronautical study indicates that the modified marking will provide adequate protection for air navigation.

d. Special.

- (1) Marking of Vehicles. Vehicles customarily used on landing areas should be marked in accordance with the provisions of Advisory Circular No. 150/5210-5, Painting, Marking and Lighting of Vehicles Used on an Airport.
- * (2) Buildings or Similar Obstructions. When the upper portion of a building or similar extensive obstruction projects above an airport imaginary surface, as described in Part 77 of the Federal Aviation Regulations, the point or edge of it highest in relation to the airport imaginary surface should be regarded as the "top of the obstruction." In certain cases, however, such as when the airport imaginary surface concerned is an approach or transition surface, i.e., sloping, this point or edge highest in relation to the airport referenced surface may not be the highest point or edge above a horizontal plane passing through the base of the object. In such cases, those portions of the object, the upper parts of which are higher above a horizontal plane passing through the base of the object than the upper part considered as the "top of the obstruction," should also be obstruction marked. *
- (3) Hazard Areas. The FAA will recommend appropriate marking in an area where towers, poles, and similar obstructions are so grouped as to present a common hazard to air commerce; where the hazard of a particular obstruction is increased by guy wires or other appurtenances; or, where an invisible hazard to aircraft in flight may exist.

CHAPTER 4. LIGHTING

- * 10. PURPOSE. The purpose of lighting an object that may be an obstruction to air navigation is to warn airmen of its presence during the hours of darkness and during periods of limited daytime light intensity and meteorological visibility. To accomplish this objective, it is necessary to display lighting on the obstruction of sufficient intensity, and in such a manner, that it will attract the attention of the pilot of any airplane that is approaching the obstruction from any angle while at any altitude up to 1,500 feet above the uppermost point on the obstruction. *
11. LOCATION OF LIGHTING. The following factors should be considered when determining the placement of obstruction lights on a structure as specified in Chapters 6, 7 and 8:
- a. Adjacent Structures. The mean elevation of the tops of the buildings in closely built up areas may be used as the equivalent of the ground level when determining the proper amount of obstruction lighting necessary to adequately mark an obstruction.
 - b. Top Lighting. The top light, or lights, displayed on an obstruction should be installed so as to mark the points or edges of the obstruction highest in relation to an airport imaginary surface, as described in Part 77 of the Federal Aviation Regulations, except that when no airport imaginary surface is involved, such top light, or lights, should be installed on the points or edges of the obstruction highest in relation to the ground, or water if so situated. If two or more edges of an extended obstruction located near any landing and takeoff area of an airport are of the same height, and obstruction lighting is to be displayed on only one of the edges, the edge nearest the landing and takeoff area should be lighted.
 - c. Shielded Lights. If a light, or lights, which is installed on an obstruction is shielded in any direction by an adjacent object, additional lights should be mounted on that object in such a way as to retain the general definition of the obstruction, the shielded light, or lights, being omitted if it does not contribute to the definition of the obstruction.

1 Jan 72

- * 12. QUALITIES OF LIGHTING. The signal emitted by hazard beacons and obstruction lights shall be aviation red in color; except that, the signal emitted by high intensity obstruction lights may be white.
- a. Aviation Red Obstruction Lights.
- (1) Intensity.
- (a) Flashing Hazard Beacon. The integral of the time-intensity curve of each flash emitted by a flashing hazard beacon, measured in the direction corresponding to the peak intensity and integrated over a period not exceeding 1.0 second, should be not less than 1,500 candle-seconds of aviation red light.
- (b) Rotating Hazard Beacon. The integral of the time-intensity curve of each flash emitted by a rotating hazard beacon, measured in the direction corresponding to the peak intensity and integrated over a period not exceeding 0.5 second, should be not less than 7,500 candle-seconds of aviation red light.
- (c) Fixed Obstruction Lights. The intensity of fixed obstruction lights should be not less than 10 candelas of aviation red light.
- (2) Distribution. The vertical and horizontal light distribution of the fixed obstruction lights should meet the requirements specified in the pertinent specifications listed in this publication. The vertical light distribution of the flashing and rotating hazard beacons should be such that the time-intensity integral of the flashes at angles between 1° and 3° above the horizontal is not less than the candle-seconds values specified above under "(1) Intensity," and the time-intensity integral at angles between 3° and 15° above the horizontal is not less than the product of these candle-seconds values multiplied by 9 over the square of the numerical value in degrees of the angle above the horizontal.
- (3) Rated Lamp Voltage. To provide satisfactory output by obstruction lights, the rated voltage of the lamp should, in each case, correspond to or be within 3 percent higher than the average voltage across the lamp during the normal hours of operation.

*

* b. High Intensity White Obstruction Lights.

- (1) Source. Advisory Circular No. 150/5345-43A, FAA/DOD Specification L-856, High Intensity Obstruction Lighting System is the publication which provides the specification requirements for these lights. The following is information from that publication.
- (2) Intensity. (Refer to paragraph 22b for transmission lines and their support structures.)
 - (a) Daytime - Visibility Less Than Five Miles. For daytime, when the meteorological visual range is less than five miles, the effective intensity of the lights should not be less than 200,000 candelas at every point in the horizontal plane.
 - (b) Daytime - Visibility Five Miles or More. For daytime, when the meteorological visual range is five miles or more, the effective intensity of the lights should be not less than 100,000 candelas at every point in the horizontal plane.
 - (c) Nighttime. For night conditions the light intensity should be reduced to 1,000 candelas.
 - (d) Nighttime - Dual Lighting Systems. In lieu of operating the high intensity white obstruction lights at a reduced intensity during night conditions, nighttime obstruction lighting may be provided by aviation red obstruction lighting installed and operated in accordance with the standards contained in Chapter 6 of this publication. (Where dual lighting systems are utilized, the high intensity white obstruction lights should be installed and operated at the closest level associated with an aviation red obstruction light or hazard beacon in accordance with the standards contained in Chapter 8 of this publication.)
- (3) Distribution.
 - (a) Vertical. The vertical beam spread everywhere around the light to 50 percent of its effective intensity shall be no less than 3° and to 10 percent of its effective intensity no less than 6°.

*

1 Jan 72

- * (b) Horizontal. The distribution of light should be at least the minimum prescribed intensity at all points on the horizontal plane.
- (c) Adjustment. Means should be provided to allow adjustment of the beam(s) after installation so that the center(s) of the beam(s) can be positioned to any point from 0° to at least 8° above the horizontal.
- (4) Measurement. The effective intensity of the light output in candelas should be determined from the Blondel-Rey equation and calculated as shown in the Illuminating Engineering Society, Guide for Calculating the Effective Intensity of Flashing Signal Lights, published in Illuminating Engineering Volume LIX p. 747 (November 1964) (available from the Illuminating Engineering Society, 345 East 47th Street, New York, New York 10017).

13. OPERATION OF OBSTRUCTION LIGHTING.

- a. Hours of Operation. Aviation red obstruction lights and hazard beacons should be operated at all times when the center of the sun's disc is 6° or more below the horizon and during daytime when flight visibility is restricted. In Alaska, this would include the period during which a prominent unlighted object cannot be seen from a distance of three statute miles or the sun is 6° or more below the horizon whichever is more restrictive.
- b. Control of Obstruction Lighting.
- (1) Aviation Red Obstruction Lighting. The operation of aviation red obstruction lighting installed on obstructions should be controlled by a satisfactory control device. The control device used should be adjusted so that the lights will be operated at all times when the north sky illuminance falls to a level of 35 footcandles and will be turned off when the north sky illuminance rises to a level of 58 footcandles, or should be continuous.

*

- * (2) High Intensity White Obstruction Lighting. The operation of high intensity white obstruction lighting installed on obstructions should be controlled by a satisfactory control device. The control device used should be adjusted so that the lights will be turned on at their highest daytime intensity when the north sky light illuminance rises to one-half footcandle, but before that illuminance level reaches three footcandles. When high intensity white obstruction lighting is displayed on an obstruction during nighttime periods, the lighting should be controlled by a satisfactory control device. The control device used should be adjusted so that the lights will be turned on at the lower (night) intensity when the north sky illuminance falls to three footcandles, but before that illuminance reaches one-half footcandle.
- (3) Dual Obstruction Lighting Systems. When high intensity white obstruction lighting is displayed on an obstruction during the daylight hours and only aviation red obstruction lighting is displayed on that obstruction during the nighttime hours, the two lighting systems should be controlled by one or more satisfactory control devices. The control devices used should be adjusted so that the high intensity white obstruction lights will be turned on and the red lights turned off when the north sky illuminance rises to one-half footcandle but before that illuminance reaches three footcandles, and will be turned off and the red lights turned on when the north sky illuminance falls to three footcandles but before that illuminance level reaches one-half footcandle.
- (4) Light Control Device. The operation of obstruction lighting displayed on obstructions should be controlled by one or more automatic time control, manual switching or light sensitive control devices. If a light-sensitive control device is used, it should be adjusted as in this subsection and installed so that the illuminance sensing device faces the north sky.
- c. Inspection of Obstruction Lighting. Obstruction lighting should be visually observed at least once each 24 hours, or checked by observing an automatic and properly maintained indicator designed to register any failure of such lights to insure that all such lights are functioning properly as required.

*

1 Jan 72

*

(1) Automatic Alarm System. In the event the obstruction lighting is not readily accessible for visual observation at least once each 24 hours, an automatic alarm system, designed to detect any failure of the lights and to provide indication of such failure, may be installed and operated to replace the normally required visual inspection. Under such conditions the FAA will not object to the side or intermediate aviation red obstruction lights on an obstruction being excluded from the alarm circuit, provided the signalling device will indicate malfunctioning of all flashing and rotating beacons and/or high intensity white lights, regardless of their position on the obstruction, and of all top lights; and that all obstruction lighting mounted on the obstruction are visually inspected at least once every two weeks, with all the lamps and/or light units being replaced at regular intervals after being lighted the equivalent of not more than 75 percent of their normal life expectancy. Xenon flash tubes are exempted from this replacement requirement.

(2) Lamp Replacement. Except as specified in paragraph 13c(1), a sufficient supply of spare lamps should be maintained for immediate replacement purposes at all times.

*

d. Notification of Light Failure. Any observed or otherwise known extinguishment or improper functioning of a flashing and rotating beacon light, regardless of its position on a natural or man-made obstruction, which will last more than 30 minutes, and any observed or otherwise known extinguishment or improper functioning of a steady burning obstruction light, installed at the top or near top of any natural or man-made obstruction, which will last more than 30 minutes, should be immediately reported. Such reports should be made by telephone or telegraph to the nearest flight service station or office of FAA and should set forth the condition of the light, or lights, the circumstance which caused the failure and the probable date that normal operation will be resumed. Further notification by telephone or telegraph should be given immediately upon resumption of normal operation by the light, or lights. Any extinguishment or improper functioning of a steady burning side or intermediate light, or lights, installed on a natural or man-made obstruction should be corrected as soon as possible, but notification of such extinguishment or improper functioning is not necessary.

e. Flashing Frequency of Aviation Red Lights.

- (1) Aviation Red Rotating Beacon. An aviation red rotating beacon should produce a flash not less than 12 times per minute nor more than 15 times per minute.
- (2) Aviation Red Flashing Beacon. An aviation red flashing beacon should be equipped with a flashing mechanism producing not more than 40 flashes per minute nor less than 12 flashes per minute with a period of darkness equal to approximately one-half the luminous period, except that the frequency of flashes of an obstruction beacon mounted on an obstruction located within 15,000 feet of the reference point of a landing area should be not less than 20 per minute. A flashing beacon may flash an International Morse Code Signal for purposes of identification, provided the code characteristic does not consist of more than two letters, the proper aviation color characteristic is retained, and the luminous output of the beacon is not affected in such a manner as to reduce the beacon's effectiveness in performing the service for which it was originally installed. The duration of the illumination and eclipse periods is important to insure a maximum light intensity. Therefore, an effort should be made to have code assignments adjusted, insofar as possible, to the following timing:

Duration of dot - 0.5 second
 Duration of dash - 1.5 seconds
 Duration of eclipse - 0.5 second between dots and dashes of a particular letter
 Duration of eclipse - 1.5 seconds between letter and repetition of single letter characteristics
 Duration of eclipse - 2.0 seconds between characteristics which contain two letters

- (a) Each proposal to have a flashing beacon flash an identifying code should be coordinated with the FAA official designated by the regional director having jurisdiction over the functions of the FAA in the area in which the particular beacon is located.
- (b) Approval must be obtained from the Federal Communications Commission for the modification of any obstruction lighting system which comes within the jurisdiction of that agency.

1 Jan 72

(3) Aviation Red Intermediate Lights. If the flashing mechanism in obstruction lighting circuits is installed so as to make it necessary for the intermediate lights to flash, the simultaneous flashing of all lights will be permissible.

* f. Flashing Frequency of High Intensity White Obstruction Lights. All high intensity white obstruction lights, except those used to mark transmission lines and their support structures, displayed on an obstruction that appear as a vertical line of lights when viewed from any direction from the obstruction should flash in synchronism; however, all such white obstruction lights displayed on an obstruction may be flashed synchronously. The flash rate of each light should be 40 flashes per minute with deviation from this flash rate not greater than plus or minus five percent.

14. SPECIAL CONDITIONS.

a. Lighting Variables. Obstruction lighting shall be displayed on smokestacks, chimneys, and similar obstructions in any of the following combinations:

(1) Aviation Red Obstruction Lights. Flashing aviation red beacons and steady burning aviation red lights, as specified in Chapter 6, during nighttime operation.

(2) High Intensity White Obstruction Lights. Flashing high intensity white obstruction lights, as specified in Chapter 7, during both daytime and nighttime operation.

(3) Combination Aviation Red and High Intensity White Obstruction Lights. A combination of flashing aviation red beacons and steady burning aviation red lights for nighttime operation and flashing high intensity white lights as specified in Chapter 8 for daytime operation.

* b. Interference. Where any obstruction lights displayed on an obstruction may present a problem to the safe operation of railway trains or motor vehicles, or may be a source of irritation to any person or persons in the vicinity of the lights, consideration should be given to mitigating or eliminating the adverse effects of the lights.

- (1) Railroads. Where aviation red obstruction lighting is installed on obstructions which are located along or near railroad rights-of-way and thereby constitutes a potential hazard to the safe operation of railway trains, extreme care should be taken to prevent any possibility of these obstruction lights being mistaken by locomotive engineers for railway signal lights. Shielding of the obstruction lights from the view of the locomotive engineers, if practicable, should be considered; the steady burning lights on the obstruction may be made to flash; or the lights at the lower levels of the obstruction may be extinguished if their extinguishment does not materially increase the hazard to air navigation caused by the presence of the obstruction.
 - (2) Other Situations. Where high intensity white lighting is installed on obstructions which are located near highways, waterways or in populated areas, the angle above the horizontal of the light beam of the lowest light may be increased or it may be found necessary to manually shield or extinguish that light, if doing so will not materially increase the hazard to air navigation, to avoid a potential hazard to surface transportation or agitation to residents of private dwellings. If the waterway is navigable, the light installation must be coordinated with the Commandant, United States Coast Guard to avoid interference with marine navigation.
 - (3) Responsibility. The FAA official designated by the regional director is responsible for assuring that such obstruction lighting installations are fully coordinated with all parties concerned and that proper corrective measures are determined and placed in effect.
- c. Day Lighting. The display of flashing or steady burning lights during daylight hours on an obstruction to provide protection in addition to that provided by the applicable marking standards described in Chapter 3, may be prescribed in some instances to more adequately warn airmen of the presence of such an obstruction.

1 Jan 72

- d. Building Lighting. When the upper portion of a building or similar extensive object projects above an airport imaginary surface, as described in Part 77 of the Federal Aviation Regulations, the point or edge highest in relation to the airport imaginary surface should be regarded as the "top of the obstruction." In certain cases, however, such as when the airport imaginary surface concerned is an approach or transition surface (i.e., sloping), this point or edge highest in relation to the airport imaginary surface may not be the highest above a horizontal plane passing through the base of the object. In such cases, additional obstruction lights should be placed on the highest part of the object as well as on the point or edge highest in relation to the airport imaginary surface.
- e. Temporary Warning Lights. When an obstruction to air navigation is presented during construction of a structure at least two lights, each light consisting of a lamp of at least 100 watts enclosed in an aviation red obstruction light globe, should be installed at the uppermost point of the structure. In addition, as the height of the structure exceeds each level at which permanent obstruction lights will be required, two similar lights should be installed at each such level. These temporary warning lights should be displayed nightly from sunset to sunrise until the permanent obstruction lights have been installed and placed in operation, and should be positioned so as to insure unobstructed visibility of at least one of the lights at each level from aircraft at any normal angle of approach. It will be permissible, in the event it is more practicable, to install and operate the permanent obstruction lighting fixtures at each required level, in lieu of the above temporary warning lights, as each such level is exceeded in height during construction.
- f. Obstruction Lighting by Nonstandard Lights. Obstruction lighting installations may utilize incandescent lamps other than those specified under the recommended lamp equipment, gaseous tubes such as neon tubes, or any method other than the conventional incandescent lamps, provided such lighting installations offer equal or greater light intensity in all angles of azimuth and elevation than that specified for standard obstruction light assemblies, afford equal or greater dependability of operation, and possess the color characteristics prescribed in Chapter 5.

CHAPTER 5. OBSTRUCTION MARKING AND LIGHTING EQUIPMENT

15. PAINT. Paint and aviation colors referred to in the standards set forth in this publication should conform with the following specifications:
- a. Federal Standard No. 595. Color guide; ready mixed paint.
 - (1) Orange No. 12197 (Aviation Surface Orange).
 - (2) White No. 17875 (Aviation White).
 - b. Aviation Surface Paint.
 - * (1) Federal Specification TT-P-59 Paint, Ready-Mixed, International Orange.
 - (2) Federal Specification TT-P-102 Paint, Oil, Titanium-Lead-Zinc and Oil, Exterior, Ready-Mixed, white and light tints. *
16. LIGHTS AND ASSOCIATED EQUIPMENT. The lighting equipment referred to in the standards set forth in this publication should conform with the applicable provisions of the following specifications and their related drawings.
- a. Aviation Red Obstruction Lighting Systems.
 - (1) Color. Military Specification MIL-C-25050 Colors; Aeronautical Lights and Lighting Equipment.
 - (2) Rotating Beacons.
 - (a) FAA Specification 291. Beacons, 36-inch, Rotating Double-Ended Type.
 - (b) Military Specification MIL-L-7158. Lamp Assembly, 24-inch, Rigid Drum-type Rotating Beacon.
 - (3) Flashing Code Beacons. FAA Specification 446. Code Beacons, 300 mm.
 - (4) Double and Single Obstruction Lights.
 - (a) Military Specification MIL-L-7830. Light, Navigational Boundary and Obstruction Markers.
 - (b) FAA Specification L-810. Specification for Obstruction Light.

1 Jan 72

- (5) Covers for Aeronautical Lights. Military Specification MIL-C-7989. Covers; Light-transmitting (for Aeronautical Lights).
- b. High Intensity White Obstruction Lighting System.
 - (1) Specification. The high intensity white lighting system referred to in the standards set forth in this publication should conform with the applicable provisions of FAA/DOD Specification L-856, High Intensity Obstruction Lighting System.
 - (2) Availability of Specifications. FAA/DOD Specification L-856 is contained in the Federal Aviation Administration Advisory Circular No. 150/5345-43A. Copies of this advisory circular may be obtained free of charge from the Department of Transportation, Distribution Unit, TAD-484.3, Washington, D. C. 20591.
 - (3) Manufacturers. The names of qualified manufacturers and a description of their equipment will be included in the Federal Aviation Administration Advisory Circular No. 150/5345-1C, Approved Airport Lighting Equipment. Copies may be obtained free of charge from the Department of Transportation, Distribution Unit, TAD-484.3, Washington, D. C. 20590. *

c. RECOMMENDED LAMP EQUIPMENT
Multiple Circuits

Typical Service	Watts	Volts or Amps.	Bulb	Base	Average Rated Lab. Life (Hours)	Approx. Lumens	Specifications	
							FAA	MIL
Double & Single Obstruction Lights	125	120V	A-21	Md. Pf.	6,000	1,220		
	116	120V	A-21	Md. Scr.	6,000	1,260	L-810	L-7830 L-7830
Airport Beacon	1,000	120V	T-20	Mg. Bip.	500	20,500	291	
	1,200	115V	T-20	Mg. Bip.	750	27,500		L-7158
Code Beacon	700	120V	PS-40	Mg. Pf.	6,000	11,200		L-6273
	620	120V	PS-40	Mg. Pf.	3,000	11,200	446	L-6273
* High Intensity White Obstruction Lights		440V 240V 120V					L-856	*

Series Circuit

Obstruction Lights		6.6A	A-21	Md. Pf.	2,000	1,020	L-810	L-7830
--------------------	--	------	------	---------	-------	-------	-------	--------

Copies of military specifications may be obtained by contacting Armed Service Electro-Standards Agency, Fort Monmouth, New Jersey 07703 or the Naval Air Systems Command, Department of the Navy, 1411 Jefferson Davis Highway, Arlington, Virginia 20360. Copies of specifications and information concerning Military and Federal specifications may be obtained from Federal Aviation Administration, Washington, D. C., 20591.

CHAPTER 6. STANDARDS FOR LIGHTING OBSTRUCTIONS TO AIR NAVIGATION WITH AVIATION RED OBSTRUCTION LIGHTS

17. PURPOSE. To provide the specifications for red obstruction lights to be placed on obstructions to air navigation.
- *18. APPLICATION. The general specifications which follow apply to the obstruction lighting of buildings, towers, smokestacks and similar obstructions, except transmission lines and their support structures.
- a. For Towers, Smokestacks and Similar Obstructions of all Heights. There should be installed at the top (or near the top if a smokestack) of the obstruction, in a manner to insure unobstructed visibility of at least one beacon from aircraft at any normal angle of approach, one, or more if required, flashing 300mm electric code beacon(s), each equipped with two lamps and aviation red color filters. The two lamps of the beacon should burn simultaneously and each lamp should be at least 500 watts. (See recommended lamp equipment chart.)
- (1) If the obstruction is skeletal by nature, such as a tower, and a rod or other construction of not more than 20 feet in height and incapable of supporting this beacon is mounted on top of the obstruction and it is determined that this additional construction does not permit unobstructed visibility of a single code beacon from any normal angle of approach, there should be installed two such beacons properly positioned to permit unobstructed viewing.
- (2) If the obstruction is solid by nature, such as a smokestack, there should be installed two or more such beacons placed at regular intervals on the horizontal plane.
- b. For Towers, Smokestacks and Similar Obstructions of all Heights. At the top of certain obstructions and at selected levels on other obstructions, there should be installed two or more lights, each light consisting of a lamp of at least 100 watts, enclosed in an aviation red obstruction light globe. These lights should be placed at regular intervals on the horizontal plane in a manner to insure unobstructed visibility of one or more lights on each level from aircraft at any normal angle of approach. *

1 Jan 72

*

- (1) If the structure is skeletal by nature, such as a tower, two lights should be installed at each level. Each light should be placed on diagonally or diametrically opposite positions of the obstruction and mounted so as to insure unobstructed visibility of at least one light. In case of a triangular or rectangular shaped tower, the lights should be mounted so as to insure unobstructed visibility of at least one light, or a light should be installed on each corner of the tower at this level. On towers more than 450 feet in height above ground, lights should be installed on each outside corner of the obstruction at each level.
- (2) If the obstruction is solid by nature, such as a smokestack, there should be installed at each level at least three lights. These lights should be placed at regular intervals on the horizontal plane in a manner to insure unobstructed view of at least two lights on each level.

c. For Towers, Smokestacks and Similar Obstructions more than 450 Feet in Overall Height. At selected levels other than the top, one or more similar flashing code beacons should be installed in such a position on the obstruction to insure unobstructed visibility of them from aircraft at any normal angle of approach.

- (1) If the obstruction is skeletal by nature, such as a tower, the beacon should be installed within the structure proper so that the structural members will not impair its visibility. In the event this is not possible, there should be installed two such beacons. Each beacon should be mounted on the outside of diagonally opposite corners on opposite sides of the structure at the prescribed height.
- (2) If the obstruction is solid by nature, such as a smokestack, two or more beacons should be installed at regular intervals on the horizontal plane in a manner to insure unobstructed visibility of at least one beacon at each level.

19. SPECIFICATIONS.

a. Towers, Poles, and Similar Obstructions. When the height of the particular obstruction above ground, or water if so situated, is:

- (1) Not more than 150 feet: At the top apply 18b(1).
- (2) More than 150 feet but not more than 300 feet:
 - (a) At the top apply 18a(1).
 - (b) At midpoint of the overall height apply 18b(1).

*

- * (3) More than 300 feet but not more than 450 feet:
(a) At the top apply 18a(1).
(b) At approximately two-thirds and one-third of the overall height apply 18b(1).
- (4) More than 450 feet but not more than 600 feet:
(a) At the top apply 18a(1).
(b) At approximately one-half of the overall height apply 18c(1).
(c) At approximately three-fourths and one-fourth of the overall height apply 18b(1).
- (5) More than 600 feet but not more than 750 feet:
(a) At the top apply 18a(1).
(b) At approximately two-fifths of the overall height apply 18c(1).
(c) At approximately four-fifths, three-fifths, and one-fifth of the overall height apply 18b(1).
- (6) More than 750 feet but not more than 900 feet:
(a) At the top apply 18a(1).
(b) At approximately two-thirds and one-third of the overall height apply 18c(1).
(c) At approximately five-sixths, one-half, and one-sixth of the overall height apply 18b(1).
- (7) More than 900 feet but not more than 1050 feet:
(a) At the top apply 18a(1).
(b) At approximately four-sevenths and two-sevenths of the overall height apply 18c(1).
(c) At approximately six-sevenths, five-sevenths, three-sevenths and one-seventh of the overall height apply 18c(1).
- (8) More than 1050 feet but not more than 1200 feet:
(a) At the top apply 18a(1).
(b) At approximately three-fourths, one-half, and one-fourth of the overall height apply 18c(1).
(c) At approximately seven-eighths, five-eighths, three-eighths, and one-eighth of the overall height apply 18b(1).*

1 Jan 72

- * (9) More than 1200 feet but not more than 1350 feet:
- (a) At the top apply 18a(1).
 - (b) At approximately two-thirds, four-ninths, and two-ninths of the overall height apply 18c(1).
 - (c) At approximately eight-ninths, seven-ninths, five-ninths, one-third, and one-ninth of the overall height apply 18b(1).
- (10) More than 1350 feet but not more than 1500 feet:
- (a) At the top apply 18a(1).
 - (b) At approximately four-fifths, three-fifths, two-fifths, and one-fifth of the overall height apply 18c(1).
 - (c) At approximately nine-tenths, seven-tenths, one-half, three-tenths, and one-tenth of the overall height apply 18b(1).
- (11) More than 1500 feet but not more than 1650 feet:
- (a) At the top apply 18a(1).
 - (b) At approximately eight-elevenths, six elevenths, four-elevenths and two-elevenths of the overall height apply 18c(1).
 - (c) At approximately ten-elevenths, nine-elevenths, seven-elevenths, five-elevenths, three-elevenths, and one-eleventh of the overall height apply 18b(1).
- (12) More than 1650 feet but not more than 1800 feet:
- (a) At the top apply 18a(1).
 - (b) At approximately five-sixths, two-thirds, one-half, one-third, and one-sixth of the overall height apply 18c(1).
 - (c) At approximately eleven-twelfths, three-fourths, seven-twelfths, five-twelfths, one-fourth, and one-twelfth of the overall height apply 18b(1).
- (13) More than 1800 feet but not more than 1950 feet:
- (a) At the top apply 18a(1).
 - (b) At approximately ten-thirteenths, eight-thirteenths, six-thirteenths, four-thirteenths, and two-thirteenths of the overall height apply 18c(1).
 - (c) At approximately twelve-thirteenths, eleven-thirteenths, nine-thirteenths, seven-thirteenths, five-thirteenths, three-thirteenths, and one-thirteenth of the overall height apply 18b(1).
- *

- * (14) More than 1950 feet but not more than 2100 feet:
- (a) At the top apply 18a(1).
 - (b) At approximately six-sevenths, five-sevenths, four-sevenths, three-sevenths, two-sevenths, and one-seventh of the overall height apply 18c(1).
 - (c) At approximately thirteen-fourteenths, eleven-fourteenths, nine-fourteenths, one-half, five-fourteenths, three-fourteenths, and one-fourteenth of the overall height apply 18b(1). *
- b. Smokestacks and Similar Obstructions. To avoid the obscurant effect of the deposits generally in evidence from this type of structure, the top lights should be installed from 5 to 10 feet below the highest point of the structure. It is important that these lights be readily accessible to enable cleaning when necessary and to facilitate lamp replacements.
- (1) Floodlighting. Smokestacks and similar obstructions may be floodlighted by fixed searchlight projectors installed at three or more equidistant points around the base of each obstruction if the searchlight projectors will provide an average illumination of at least 15 footcandles at the top one-third of the obstruction.
 - * (2) When the height of the particular obstruction above ground or water, if so situated is:
 - (a) Not more than 150 feet: At a near top level apply 18b(2).
 - (b) More than 150 feet but not more than 300 feet:
 - 1 At a near top level apply 18a(2)
 - 2 At midpoint of the overall height apply 18b(2).
 - (c) More than 300 feet but not more than 450 feet:
 - 1 At a near top level apply 18a(2).
 - 2 At approximately two-thirds and one-third of the overall height apply 18b(2).
 - (d) More than 450 feet but not more than 600 feet:
 - 1 At a near top level apply 18a(2).
 - 2 At approximately one-half of the overall height apply 18c(2).
 - 3 At approximately three-fourths and one-fourth of the overall height apply 18b(2). *

1 Jan 72

*

- (e) More than 600 feet but not more than 750 feet:
- $\frac{1}{2}$ At a near top level apply 18a(2).
 - $\frac{2}{2}$ At approximately two-fifths of the overall height apply 18c(2).
 - $\frac{3}{2}$ At approximately four-fifths, three-fifths and one-fifth of the overall height apply 18b(2).
- (f) More than 750 feet but not more than 900 feet:
- $\frac{1}{2}$ At a near top level apply 18a(2).
 - $\frac{2}{2}$ At approximately two-thirds and one-third of the overall height apply 18c(2).
 - $\frac{3}{2}$ At approximately five-sixths, one-half and one-sixth of the overall height apply 18b(2).
- (g) More than 900 feet but not more than 1050 feet:
- $\frac{1}{2}$ At a near top level apply 18a(2).
 - $\frac{2}{2}$ At approximately four-sevenths and two-sevenths of the overall height apply 18c(2).
 - $\frac{3}{2}$ At approximately six-sevenths, five-sevenths, three-sevenths, and one-seventh of the overall height apply 18b(2).
- (h) More than 1050 feet but not more than 1200 feet:
- $\frac{1}{2}$ At a near top level apply 18a(2).
 - $\frac{2}{2}$ At approximately three-fourths, one-half, and one-fourth of the overall height apply 18c(2).
 - $\frac{3}{2}$ At approximately seven-eighths, five-eighths, three-eighths, and one-eighth of the overall height apply 18b(2).
- (i) More than 1200 feet but not more than 1350 feet:
- $\frac{1}{2}$ At a near top level apply 18a(2).
 - $\frac{2}{2}$ At approximately two-thirds, four-ninths, and two-ninths of the overall height apply 18c(2).
 - $\frac{3}{2}$ At approximately eight-ninths, seven-ninths, five-ninths, one-third, and one-ninth of the overall height apply 18b(2).
- (j) More than 1350 feet but not more than 1500 feet:
- $\frac{1}{2}$ At a near top level apply 18a(2).
 - $\frac{2}{2}$ At approximately four-fifths, three-fifths, two-fifths, and one-fifth of the overall height apply 18c(2).
 - $\frac{3}{2}$ At approximately nine-tenths, seven-tenths, one-half, three-tenths, and one-tenth of the overall height apply 18b(2).

*

*

- (k) More than 1500 feet but not more than 1650 feet:
- 1 At a near top level apply 18a(2).
 - 2 At approximately eight-elevenths, six-elevenths, four-elevenths, and two-elevenths of the overall height apply 18c(2).
 - 3 At approximately ten-elevenths, nine-elevenths, seven-elevenths, five-elevenths, three-elevenths, and one-eleventh of the overall height apply 18b(2).
- (l) More than 1650 feet but not more than 1800 feet:
- 1 At a near top level apply 18a(2).
 - 2 At approximately five-sixths, two-thirds, one-half, one-third, and one-sixth of the overall height apply 18c(2).
 - 3 At approximately eleven-twelfths, three-fourths, seven-twelfths, five-twelfths, one-fourth and one-twelfth of the overall height apply 18b(2).
- (m) More than 1800 feet but not more than 1950 feet:
- 1 At a near top level apply 18a(2).
 - 2 At approximately ten-thirteenths, eight-thirteenths, six-thirteenths, four-thirteenths, and two-thirteenths of the overall height apply 18c(2).
 - 3 At approximately twelve-thirteenths, eleven-thirteenths, nine-thirteenths, seven-thirteenths, five-thirteenths, three-thirteenths, and one-thirteenth of the overall height apply 18b(2).
- (n) More than 1950 feet but not more than 2100 feet:
- 1 At a near top level apply 18a(2).
 - 2 At approximately six-sevenths, five-sevenths, four-sevenths, three-sevenths, two-sevenths, and one-seventh of the overall height apply 18c(2).
 - 3 At approximately thirteen-fourteenths, eleven-fourteenths, nine-fourteenths, one-half, five-fourteenths, three-fourteenths, and one-fourteenth of the overall height apply 18b(2). *

1 Jan 72

c. Prominent Building and Similar Extensive Obstructions. Prominent buildings and similar extensive obstructions should be lighted in accordance with the following specifications. In the event the individual objects of a group of obstructions are approximately the same overall height above ground, or water if so situated, and are located not more than 150 feet apart, the group of obstructions may be considered an extensive obstruction and so lighted.

(1) When the particular obstruction is not more than 150 feet in overall height above ground, or water if so situated:

- (a) If the obstruction is not more than 150 feet in either horizontal dimension, there should be installed at approximately the highest point or edge at each end of the major axis of the obstruction at least one light, consisting of a lamp of at least 100 watts, enclosed in an aviation red obstruction light globe. These lights should be positioned so as to insure unobstructed visibility of them from aircraft at any normal angle of approach, and to indicate the general extent of the obstruction; or, if the shape of the obstruction is such as to make this manner of lighting impracticable, there may be installed two such lights at the approximate center of the highest point or edge of the obstruction. Both lights should burn simultaneously and be so positioned as to insure unobstructed visibility of at least one of the lights from aircraft at any normal angle of approach.
- (b) If the obstruction is more than 150 feet in one horizontal dimension, but not more than 150 feet in the other, there should be installed at least one light, consisting of a lamp of at least 100 watts enclosed in an aviation red obstruction light globe, for each 150 feet, or fraction thereof, of the overall length of the major axis of the obstruction. At least one of these top lights should be installed on the highest point or edge of each end of the obstruction, with the additional lights as required spaced at approximately equal intervals not exceeding 150 feet, on the highest points or edge between the end lights in a manner to indicate the extent of the obstruction and to insure unobstructed visibility of the lights from aircraft at any normal angle of approach. If there are two or more edges of the same height on such an obstruction located near a landing area, the edge nearest the landing area should be lighted.

- (c) If the obstruction is more than 150 feet in both horizontal dimensions, there should be installed at least one light, consisting of a lamp of at least 100 watts enclosed in an aviation red obstruction light globe, on the highest point of each corner of the obstruction. In addition, there should be installed at least one similar light for each 150 feet, or fraction thereof, when the distance between the corner lights exceeds 150 feet. These additional lights should be installed at approximately equal intervals, at the highest points along the outer edges of the obstruction, between the corner lights in a manner to indicate the general extent and definition of the obstruction and to insure unobstructed visibility of the lights from aircraft at any normal angle of approach.
- (d) In the event there are one or more points within the outer edges of the obstruction, the uppermost parts of which are higher than the highest level of the lights prescribed above, at least one similar light should be displayed from the top of each such point.
- (2) When the particular obstruction is more than 150 feet in overall height above ground, or water if so situated:
- (a) Top lights should be installed on the obstruction in the manner set forth in the applicable provisions of Section d(1) above.
- (b) Intermediate lights, each consisting of a lamp of at least 100 watts enclosed in an aviation red obstruction light globe, should be provided for each 150 feet, or fraction thereof, the obstruction exceeds 150 feet in overall height above ground, or water if so situated. The position of these intermediate lights on the vertical plane should be as close to the equidistant levels between the top lights and the ground level as the particular shape and type of obstruction will permit. One such light should be installed at each outside corner of the obstruction at each level and also one such light should be installed at equal intervals on the horizontal plane on each outer surface at each level between adjacent corner lights, for each 150 feet, or fraction thereof, when the overall horizontal distance between such adjacent corner lights exceeds 150 feet.

1 Jan 72

- 1 In lieu of installing the obstruction lights on the obstruction, a pole or poles of a height slightly greater than the overall height of the obstruction may be installed on or adjacent to the obstruction and lighted in accordance with the specifications prescribed in Section 19a.
 - 2 It is important that those towers, poles, or similar structures be installed in such a manner as to indicate the general definition and extent of the obstruction.
- (c) In the event early or special warning is considered necessary to provide adequate protection for aircraft, the top lights on each obstruction as required under Section d(1) and d(2) above, should be replaced with one or more flashing 300mm electric code beacons as described in Section 18a.
- (d) Where obstructions are extensive as in the case of a line of trees or hills, and the use of the fixed obstruction lights would be impracticable or inadequate, flashing or rotating hazard beacons may be used as an alternate to the fixed obstruction lights. Such beacons should be located on the highest points or edges of the extended obstruction at intervals not exceeding 3,000 feet, provided at least three beacons are placed on any one side or edge of the extensive obstruction to indicate a line of lights. The flashing or rotating beacons should be of the type described in Chapter 5 of this circular.
- d. Bridges. The superstructure of a bridge should be lighted in accordance with the following specifications. However, where the bridge structure is over navigable water, approval of the lighting installation must be obtained from the Commandant of the United States Coast Guard to avoid interference with marine navigation.
- (1) When the bridge Superstructure is not more than 150 feet in overall length: There should be installed at the approximate center of the highest point of the superstructure at least two lights, each light consisting of a lamp of at least 100 watts, enclosed in aviation red obstruction light globes. The two lights should burn simultaneously and should be positioned so as to insure unobstructed visibility of at least one of the lights from aircraft at any normal angle of approach.

- (2) When the bridge superstructure is more than 150 feet in overall length:
- (a) There should be installed for each 150 feet, or fraction thereof, of the overall length of the bridge superstructure one or more lights, each light consisting of a lamp of at least 100 watts, enclosed in aviation red obstruction light globes. These lights should be installed on the highest points of the superstructure at approximately equal intervals not exceeding 150 feet in a manner to indicate the general definition and extent of the obstruction, and to insure unobstructed visibility of the lights from aircraft at any normal angle of approach. The distance not exceeding 600 feet when the particular bridge is located more than 15,000 feet from the reference point of any landing area.
 - (b) Where the bridge superstructure exceeds 150 feet in overall length and the use of the above described obstruction lights would be impracticable or inadequate, flashing or rotating hazard beacons should be used as an alternate to the fixed obstruction lights. Such beacons should be located on the highest points or edge of the bridge superstructure at intervals not exceeding 3,000 feet, provided at least three beacons are installed to indicate the extent of the obstruction. The flashing or rotating beacons should be of the type described in Chapter 5 of this circular.
- e. Water Towers, Grain Elevators, Gas Holders, and Similar Obstructions. Water towers, grain elevators, gas holders, and similar obstructions should be lighted in accordance with the following specifications, when the particular obstruction is:
- (1) Not more than 150 feet in overall height above ground, or water if so situated:
 - (a) At the top apply 18b(1).
 - (2) More than 150 feet but not more than 300 feet:
 - (a) At the top apply 18a(1).
 - (b) At the approximate midpoint of the overall height (as equidistant between the ground and the top of the structure as the shape of the obstruction will permit) apply 18b(2).

1 Jan 72

- (3) More than 300 feet but not more than 450 feet:
- (a) At the top apply 18a(1).
 - (b) At approximately two-thirds and one-third of the overall height apply 18b(2).

f. Group of Structural Hazards. Towers, poles, tanks, smokestacks, and similar obstructions which are so grouped as to present a common potential hazard to air navigation should be lighted in accordance with the following specifications:

- (1) This specification applies to a group of closely spaced towers, poles, tanks, smokestacks, or similar obstruction of approximately the same overall height above ground, or water if so situated, in which the spacing between the individual structures does not exceed 150 feet. The group may be considered an extensive obstruction and lighted in accordance with Section C. "Prominent Buildings and Similar Extensive Obstructions."
- (2) This specification applies to a group of closely spaced towers, poles, tanks, smokestacks, and similar obstructions which may or may not be of the same overall height, in which the spacing between the individual structures is not in all cases equal to or less than 150 feet. Each prominent object within the group should be lighted in accordance with the specifications prescribed in the section for individual towers, poles and similar obstructions of a corresponding overall height above ground, or water if so situated.
 - (a) In addition, there should be installed at the top of a prominent center obstruction or on a special tower located near the center of the group of obstructions, at least one rotating beacon producing aviation red flashes.
 - (b) The rotating beacon should be of the type described in Chapter 5 of this circular.

- g. Trees. A line of trees, with the individual trees located less than 150 feet apart, or a tree-covered area should be lighted as an extensive obstruction as specified in Paragraph 19c, Prominent Buildings and Similar Extensive Obstructions, with the obstruction lights mounted on poles or towers, of a height slightly greater than the height of the outstanding trees. Individual trees and widely-spaced trees should be lighted in accordance with the following specification: Poles of a height slightly greater than the height of the outstanding tree(s) should be installed adjacent to the tree(s) and lighted in accordance with Section 19a.

- h. Hazard Areas. An area in which a visible or invisible hazard exists or is proposed should be lighted as prescribed by FAA. This lighting would be in addition to such lighting as may be necessary on any natural or man-made obstruction located within the area.

* CHAPTER 7. STANDARDS FOR LIGHTING OBSTRUCTIONS TO AIR NAVIGATION WITH HIGH INTENSITY WHITE OBSTRUCTION LIGHTS

20. PURPOSE. To provide the specifications for high intensity white obstruction lights to be placed on obstructions to air navigation.
21. APPLICATION. The general specifications which follow apply to the obstruction lighting of buildings, smokestacks and similar obstructions, except transmission lines and their support structures. These standards do not require modification of existing marking and lighting; however, the FAA may recommend that marking and lighting displayed on an existing structure, that would come within the scope of these standards, be modified if that structure is altered or replaced by a similar structure.
- a. For Smokestacks and Similar Obstructions (Excluding Antenna Structures and Transmission Line Support Structures).
- (1) There should be installed at the top (or near the top if a smokestack) of the obstruction, a light or lights in a manner to insure unobstructed visibility of at least one light from aircraft at any normal angle of approach. If the obstruction is solid by nature, such as a smokestack, there should be installed four such lights placed at regular intervals on the horizontal plane.
 - (2) For smokestacks and similar obstructions more than 300 feet but not more than 600 feet in overall height there should be installed one additional level of lights, (other than the top level), in such a position on the obstruction to insure unobstructed visibility of them from aircraft at any normal angle of approach.
 - (3) For smokestacks and similar obstructions more than 600 feet in overall height there should be installed one additional level of lights (other than the top level) for each additional 400 feet, or fraction thereof, of total structure height.
 - (4) The angular adjustment of the beam peak above the horizon should be determined during the FAA aeronautical study to insure minimum effect on people residing near the structure and the greatest safety to airmen. The angular adjustment of the lights should be such that the beams of all lights do not strike the ground closer than three statute miles from the structure.

*

1 Jan 72

- * b. Antenna Towers and Similar Open Structures. Not applicable to these types of structures at this time.

22. SPECIFICATIONS.

- a. High Intensity White Obstruction Lighting on Smokestacks and Similar Obstructions. To avoid the obscurant effect of the deposits generally in evidence from this type of structure, the top lights should be installed from 5 to 10 feet below the highest point of the structure. It is important that these lights be readily accessible to enable cleaning when necessary and to facilitate lamp replacements.

- (1) When the height of the particular obstruction above ground or water, if so situated, is:

- (a) Not more than 300 feet: At a near top level apply 21a(1).
- (b) More than 300 feet but not more than 600 feet:
 $\frac{1}{2}$ At a near top level apply 21a(1).
 $\frac{2}{2}$ At a point equal to approximately one-half of the overall height apply 21a(3).
- (c) More than 600 feet but not more than 1000 feet:
 $\frac{1}{2}$ At a near top level apply 21a(1).
 $\frac{2}{2}$ At approximately two-thirds and one-third of the overall height, apply two additional levels in accordance with 21a(3).
- (d) More than 1000 feet but not more than 1400 feet:
 $\frac{1}{2}$ At a near top level apply 21a(1).
 $\frac{2}{2}$ At approximately three-fourths, one-half and one-fourth of the overall height apply three additional levels in accordance with 21a(3).
- (e) More than 1400 feet but not more than 1800 feet:
 $\frac{1}{2}$ At a near top level apply 21a(1).
 $\frac{2}{2}$ At approximately four-fifths, three-fifths, two-fifths and one-fifth of the overall height apply four additional levels in accordance with 21a(3). *

- * (f) More than 1800 feet but not more than 2100 feet:
- 1 At a near top level apply 21a(1).
 - 2 At approximately five-sixths, two-thirds, one-half, one-third, and one-sixth of the overall height apply six additional levels in accordance with 21a(3).

b. Transmission lines.

- (1) The catenary of transmission lines or similar obstructions should be identified in accordance with the following specifications. The towers, poles, or similar structures supporting such a line should be lighted in accordance with appropriate specifications in Paragraph 19a except as noted below:
- (a) A system of three sequentially flashing white lights should be installed on each transmission line supporting structure (or adjacent terrain).
 - (b) Each light should flash at 60 flashes per minute. A plus or minus five percent tolerance due to environmental circumstances is allowed.
 - (c) One light should be at the top of the structure, one light should be at the height above ground or water of the lowest point in the catenary, and one light should be approximately midway between the other two lights. The middle light should normally be a minimum of 50 feet from the other two lights. The vertical and horizontal arrangements of the lights may be subject to the structural limits of the towers and/or adjacent terrain and a tolerance of 20 percent from uniform spacing of the bottom and middle light is allowed. If the base of the supporting tower(s) is higher than the lowest point in the catenary, such as a canyon crossing, one or more lights shall be installed on the adjacent terrain at the level of the lowest point of the span.
 - (d) The middle light should flash first, the top light should flash second and the bottom light should flash last. The OFF interval between the second and third light should be about twice as long as between the first and second light. The interval between the end of one sequence and beginning of the next should be about ten times the interval between the first and second light. The ON time of any flash normally should not be less than 20 microseconds or more than 50 milliseconds. The ON time is the time when the instantaneous intensity exceeds the effective intensity. *

1 Jan 72

*

- (e) The effective intensity 1/ for 180 degrees horizontal, centered on the transmission line, should be no less than 100,000 2/ candelas during the day and between 500 2/ to 1,000 2/ candelas during the night. The peak of the effective intensity should be approximately at the center of the beam. A tolerance of plus or minus five percent due to environmental circumstances is allowed.
- (f) The horizontal beam spread, centered on the transmission line, should be 180 degrees.
- (g) The vertical beam spread, to 50 percent of the effective intensity, should be no less than three degrees, and to ten percent of effective intensity, should be no less than six degrees.
- (h) The lights should flash white and may be made up of one or more light fixtures at each level in order to obtain the specified horizontal spread, (i.e., two 90 degree lamps may be joined to produce 180 degrees total horizontal spread). All lights operated in the same direction should provide the required sequential operation in that direction.
- (i) The lights should be adjustable and shielded so that the beam peak can be tilted up above the horizon to prevent glare from the light from disturbing persons on the ground. In the case of a transmission line(s) located within the approach area of a runway, shielding and beam adjustment of the lights should also be employed to prevent blinding a pilot.
- (j) A light sensitive control device, an automatic time control, or a manual switch should be provided to change the intensity of the light for operation from sunset to sunrise and vice versa.

1/ The effective intensity of the light should be determined from the Illuminating Engineering Society, Guide for Calculating the Effective Intensity of Flashing Signal Lights, published in Illuminating Engineering, Vol. LIX., p. 747 (Nov. 1964) (available from the Illuminating Engineering Society, 345 East 47th Street, New York, New York 10017).

2/ Intensity sufficient to be adequately visible in the day and night at three miles in three miles meteorological visibility is desired.

*

- * (2) The area in the immediate vicinity of the base of the supporting structures should be cleared of all structures and objects of natural growth that could interfere with the line of sight between a pilot and the lights.
- (3) When this complete lighting system is employed, the following marking and lighting is not required:
 - (a) Spherical markers (Chapter 3, paragraph 8b);
 - (b) The marking of the supporting structures (Chapter 3, paragraphs 8 and 9), for the surface area having the same exposure covered by this lighting system; and,
 - (c) The installation of obstruction lights on the supporting structures (Chapter 6, paragraph 19), designed to serve the same exposure covered by this lighting system.
- (4) The precise final adjustments of the system for each installation are subject to study by FAA field offices to insure the best optimum adjustments for residents and pilots. *

1 Jan 72

* CHAPTER 8. STANDARDS FOR DUAL LIGHTING SYSTEMS ON OBSTRUCTIONS TO AIR NAVIGATION

23. PURPOSE. To provide the specifications for dual obstruction lighting systems to be placed on obstructions to air navigation.
24. APPLICATION. The general specifications which follow apply to the obstruction lighting of buildings, smokestacks and similar obstructions, except transmission lines and their support structures. These standards do not require modification of existing marking and lighting; however, the FAA may recommend that marking and lighting displayed on an existing structure, that would come within the scope of these standards, be modified if that structure is altered or replaced by a similar structure.
25. SPECIFICATIONS.
- a. Dual Obstruction Lighting Systems on Smokestacks and Similar Obstructions. Where both the red obstruction lighting and high intensity white obstruction lighting systems are to be used for night and day obstruction lighting respectively, the obstruction lights should be installed as follows:
- (1) Structures not more than 150 feet: At a near top level apply 18b(2).
 - (2) Structures more than 150 feet but not more than 300 feet:
 - (a) Red lights, apply 19b(2)(b).
 - (b) White lights, at a near top level apply 21a(1).
 - (3) Structures more than 300 feet but not more than 450 feet:
 - (a) Red lights, apply 19b(2)(c).
 - (b) White lights,
 - $\frac{1}{2}$ At a near top level apply 21a(1).
 - $\frac{2}{2}$ At approximately two-thirds of the overall height apply 21a(2).
 - (4) Structures more than 450 feet but not more than 600 feet:
 - (a) Red lights, apply 19b(2)(d).
 - (b) White lights,
 - $\frac{1}{2}$ At a near top level apply 21a(1).
 - $\frac{2}{2}$ At approximately one-half of the overall height apply 21a(2).

*

- * (5) Structures more than 600 feet but not more than 750 feet:
- (a) Red lights, apply 19b(2)(e).
 - (b) White lights,
 - $\frac{1}{2}$ At a near top level apply 21a(1).
 - $\frac{2}{2}$ At approximately four-fifths and two-fifths of the overall height apply 21a(3).
- (6) Structures more than 750 feet but not more than 900 feet:
- (a) Red lights, apply 19b(2)(f).
 - (b) White lights,
 - $\frac{1}{2}$ At a near top level apply 21a(1).
 - $\frac{2}{2}$ At approximately two-thirds and one-third of the overall height apply 21a(3).
- (7) Structures more than 900 feet but not more than 1000 feet:
- (a) Red lights, apply 19b(2)(g).
 - (b) White lights,
 - $\frac{1}{2}$ At a near top level apply 21a(1).
 - $\frac{2}{2}$ At approximately five-sevenths and two-sevenths of the overall height apply 21a(3).
- (8) Structures more than 1000 feet but not more than 1050 feet:
- (a) Red lights, apply 19b(2)(g).
 - (b) White lights,
 - $\frac{1}{2}$ At a near top level apply 21a(1).
 - $\frac{2}{2}$ At approximately five-sevenths, four-sevenths and two-sevenths of the overall height apply 21a(3).
- (9) Structures more than 1050 feet but not more than 1200 feet:
- (a) Red lights, apply 19b(2)(h).
 - (b) White lights,
 - $\frac{1}{2}$ At a near top level apply 21a(1).
 - $\frac{2}{2}$ At approximately three-fourths, one-half, and one-fourth of the overall height apply 21a(3).
- (10) Structures more than 1200 feet but not more than 1350 feet:
- (a) Red lights, apply 19b(2)(i).
 - (b) White lights,
 - $\frac{1}{2}$ At a near top level apply 21a(1).
 - $\frac{2}{2}$ At approximately seven-ninths, four-ninths, and two-ninths of the overall height apply 21a(3).
- *

1 Jan 72

- * (11) Structures more than 1350 but not more than 1400 feet:
- (a) Red lights, apply 19b(2)(j).
 - (b) White lights,
 - $\frac{1}{2}$ At a near top level apply 21a(1).
 - $\frac{2}{5}$ At approximately four-fifths, one-half, and one-fifth of the overall height apply 21a(3).
- (12) Structures more than 1400 feet but not more than 1500 feet:
- (a) Red lights, apply 19b(2)(j).
 - (b) White lights,
 - $\frac{1}{2}$ At a near top level apply 21a(1).
 - $\frac{2}{5}$ At approximately four-fifths, three-fifths, two-fifths, and one-fifth of the overall height apply 21a(3).
- (13) Structures more than 1500 feet but not more than 1650 feet:
- (a) Red lights, apply 19b(2)(k).
 - (b) White lights,
 - $\frac{1}{2}$ At a near top level apply 21a(1).
 - $\frac{2}{11}$ At approximately nine-elevenths, seven-elevenths, four-elevenths, and two-elevenths of the overall height apply 21a(3).
- (14) Structures more than 1650 feet but not more than 1800 feet:
- (a) Red lights, apply 19b(2)(l).
 - (b) White lights,
 - $\frac{1}{2}$ At a near top level apply 21a(1).
 - $\frac{2}{12}$ At approximately five-sixths, seven-twelfths, five-twelfths, and one-sixth of the overall height apply 21a(3).
- (15) Structures more than 1800 feet but not more than 1950 feet:
- (a) Red lights, apply 19b(2)(m).
 - (b) White lights,
 - $\frac{1}{2}$ At a near top level apply 21a(1).
 - $\frac{2}{13}$ At approximately eleven-thirteenths, nine-thirteenths, six-thirteenths, four-thirteenths, and two-thirteenths of the overall height apply 21a(3). *

1 Jan 72

AC 70/7460-1A

- * (16) Structures more than 1950 feet but not more than 2100 feet:
- (a) Red lights, apply 19b(2)(n).
 - (b) White lights,
 - $\frac{1}{2}$ At a near top level apply 21a(1).
 - $\frac{2}{2}$ At approximately six-sevenths, nine-fourteenths, one-half, five-fourteenths, and one-seventh of the overall height apply 21a(3).
- b. Antenna Towers and Similar Open Structures. Not applicable to these types of structures at this time. *

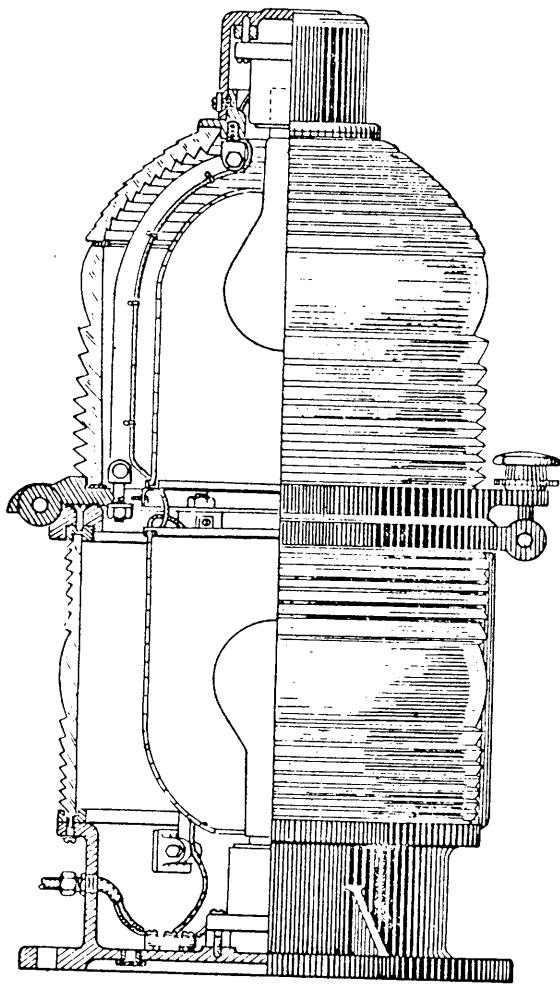

300 mm ELECTRIC CODE BEACON
(Fresnel Lens)

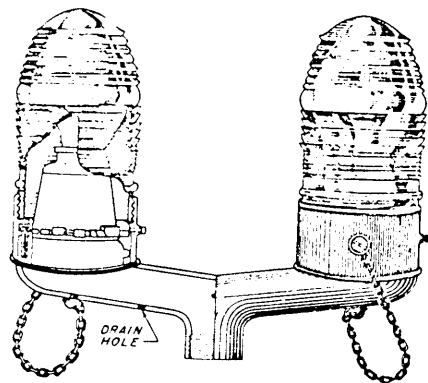

DOUBLE OBSTRUCTION
LIGHT FITTING
(Fresnel Globe)



SINGLE OBSTRUCTION
LIGHT FITTING
(Fresnel Globe)

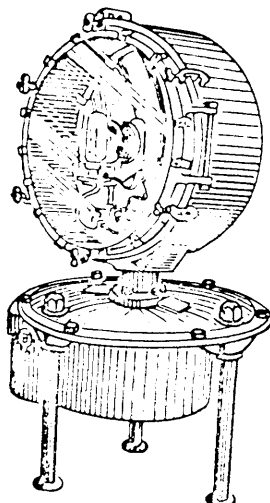

24-Inch Single End

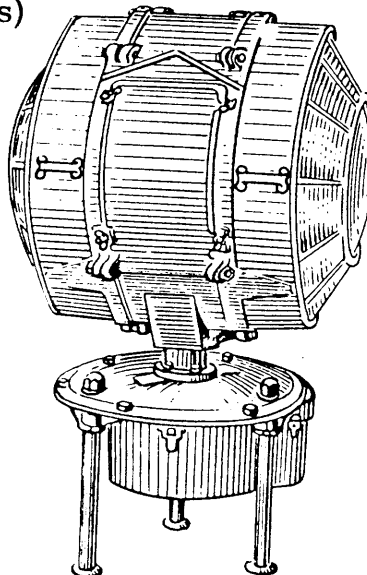

36-Inch Double End

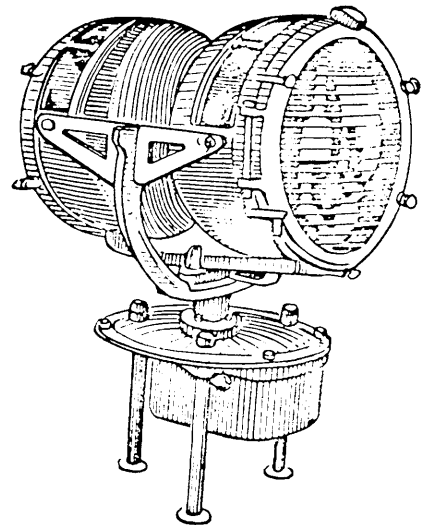

24-Inch Double End
ROTATING BEACONS

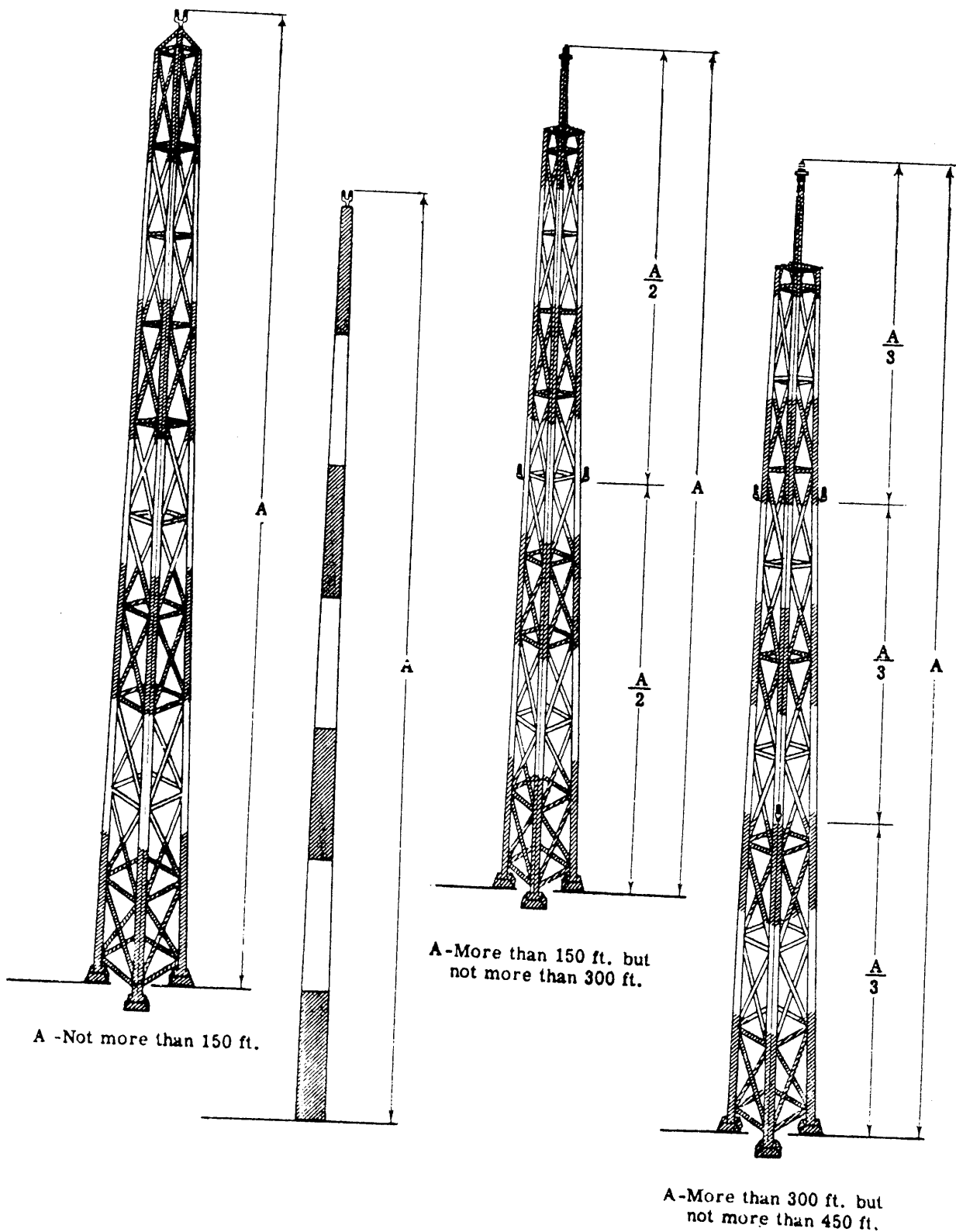

PAINING AND LIGHTING OF TOWERS, POLES AND SIMILAR OBSTRUCTIONS

1 Jan 72

AC 70/7460-1A
Appendix i

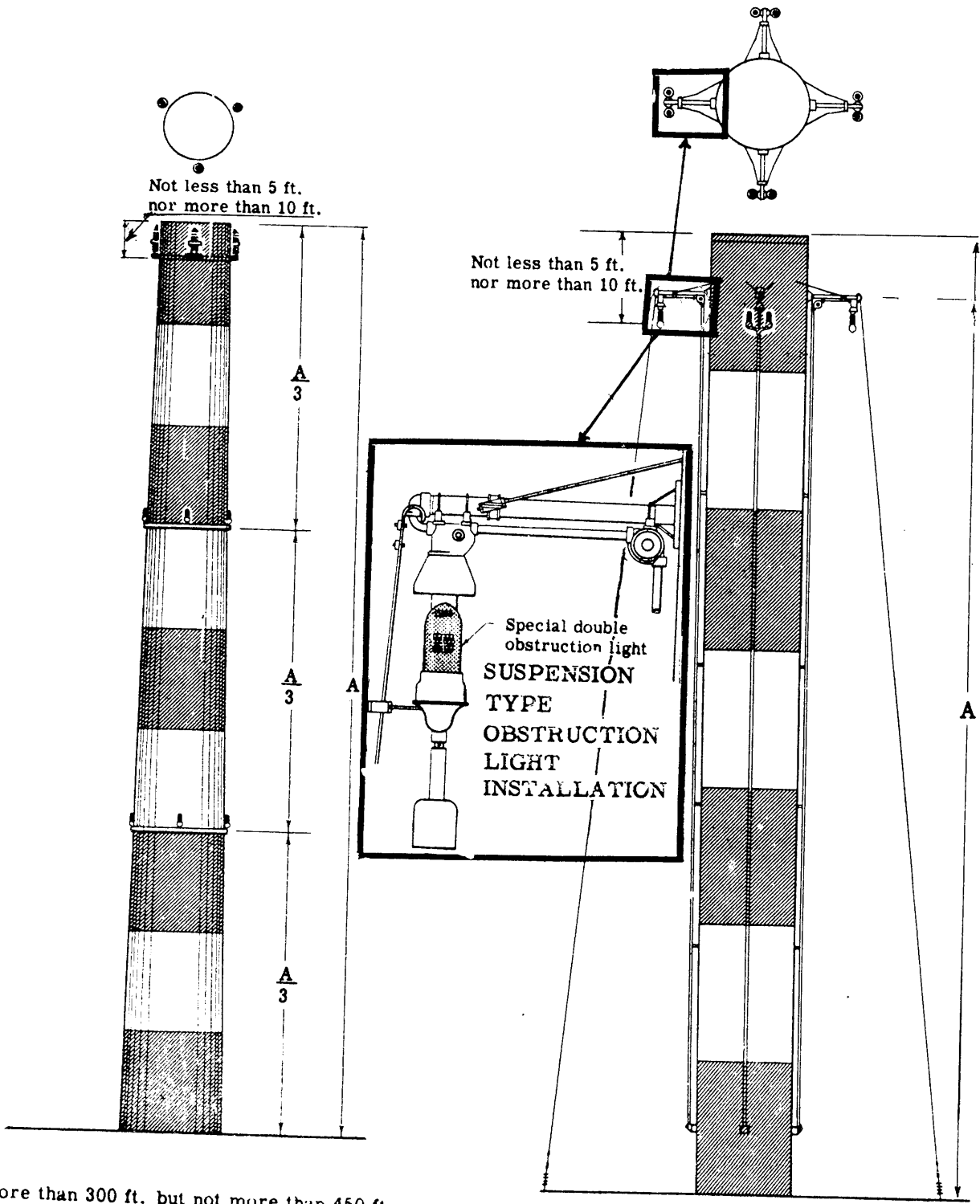

A-More than 300 ft. but not more than 450 ft.

A-Not more than 150 ft.

PAINTING AND LIGHTING OF SMOKESTACKS AND SIMILAR OBSTRUCTIONS

1 Jan 72

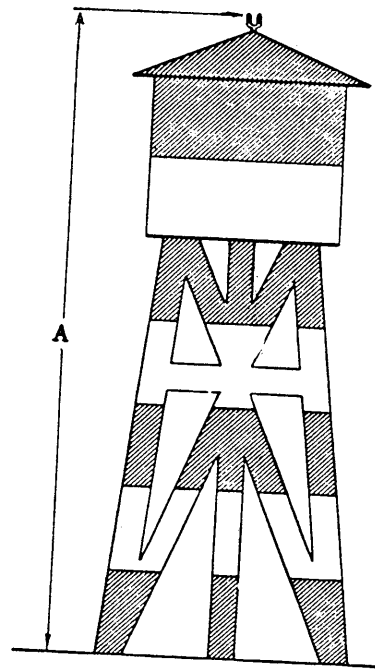
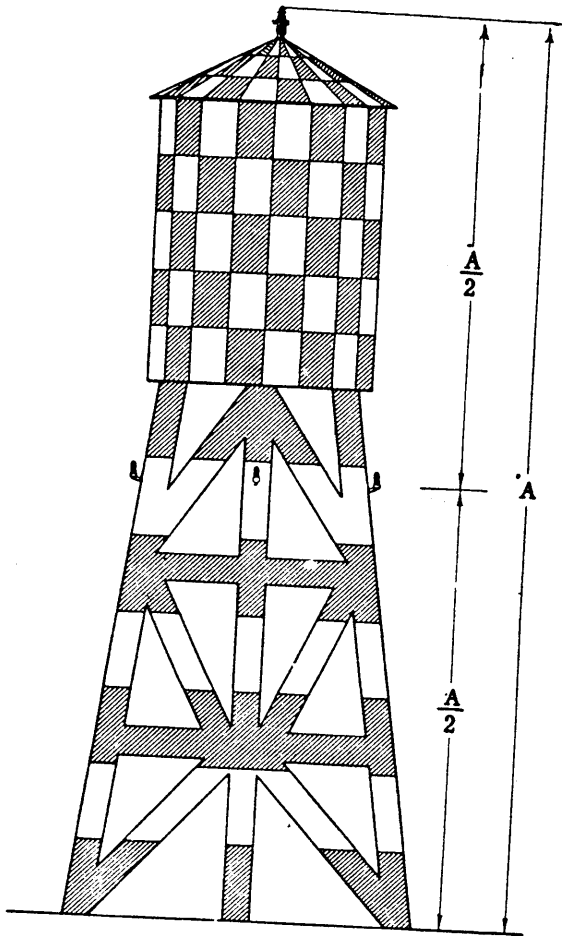
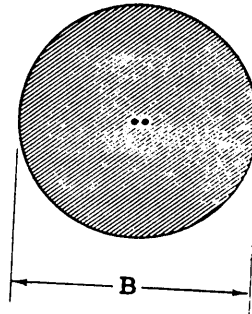
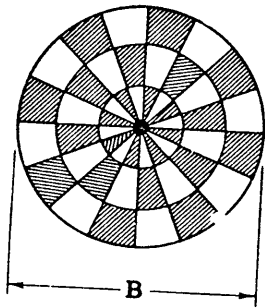

LIGHTING

A-More than 150 ft. but
not more than 300 ft.
B-Not more than 150 ft.

MARKING

A and B- 15 ft.
or more

LIGHTING

A and B-Not more
than 150 ft.

MARKING

A-5 ft. or more
B-Less than 15 ft.

PAINTING AND LIGHTING OF WATER TOWERS AND SIMILAR OBSTRUCTIONS

1 Jan 72

AC 70/7460-1A
Appendix 1

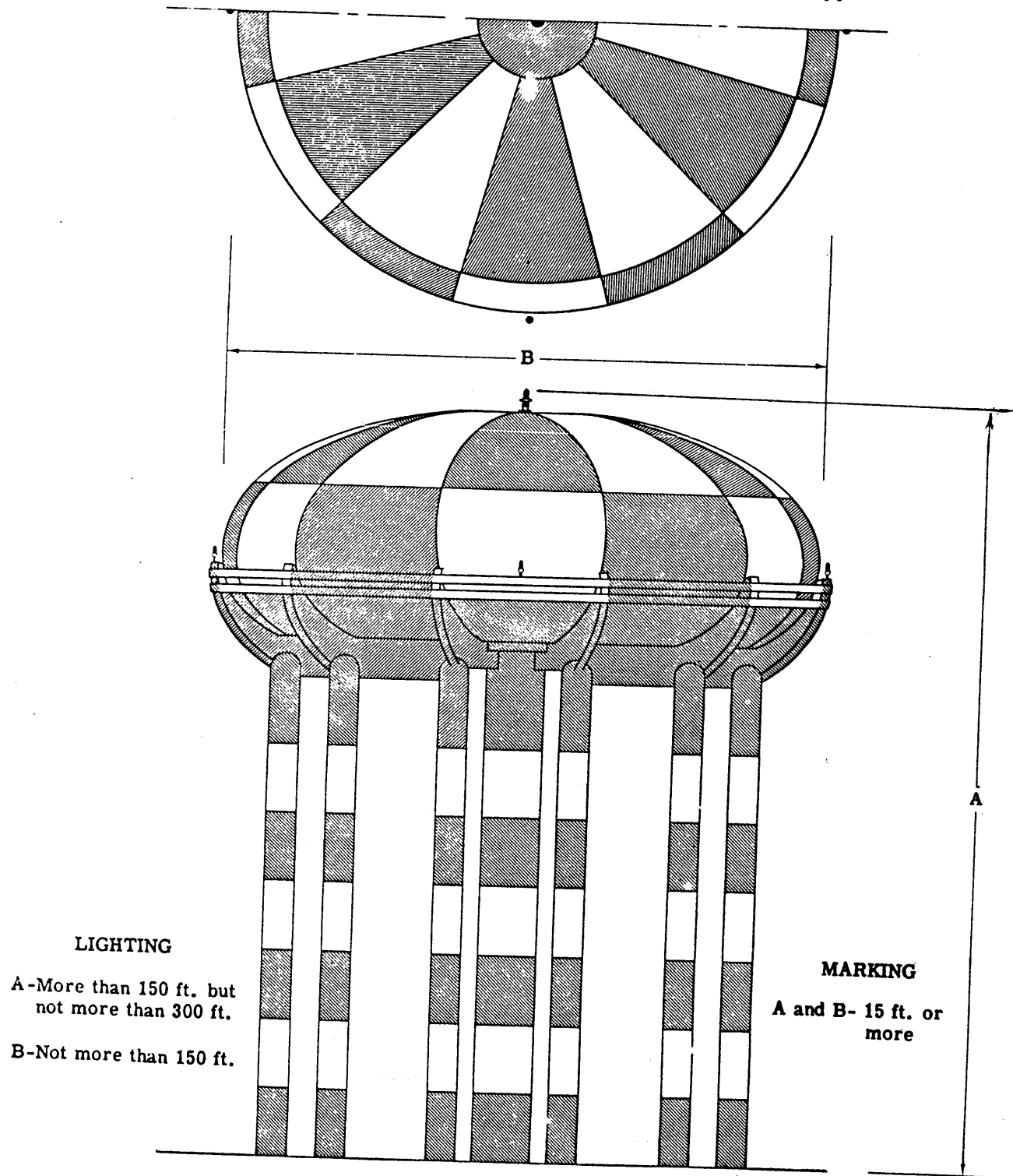

1 Jan 72

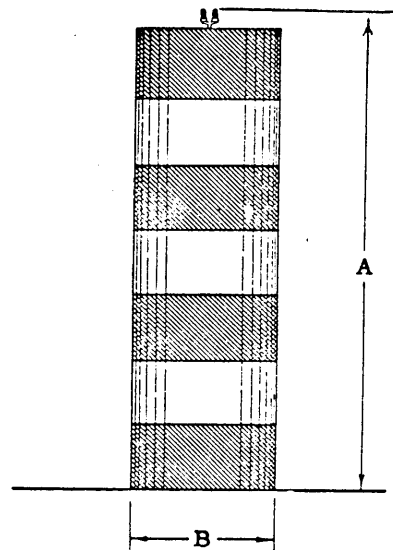
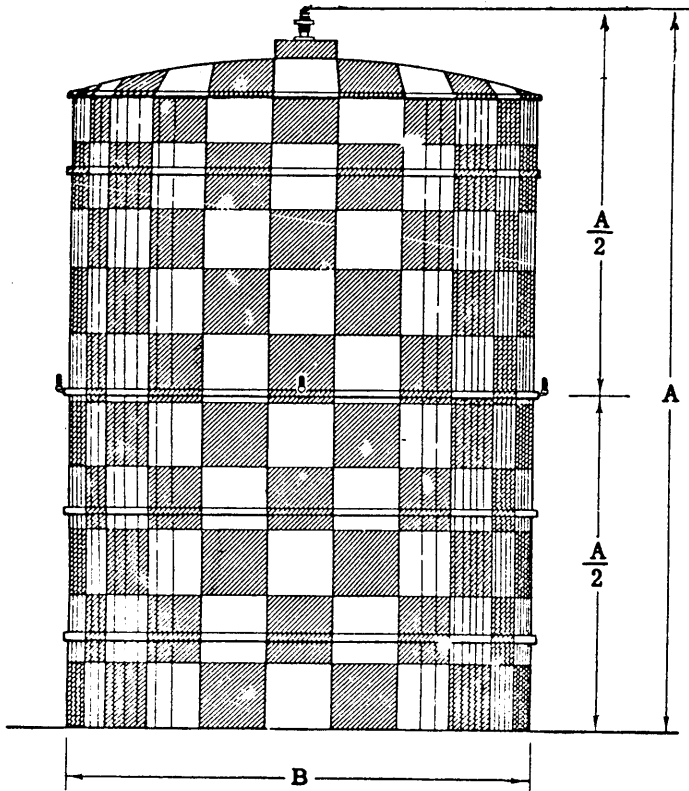
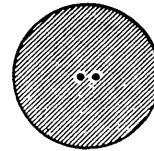
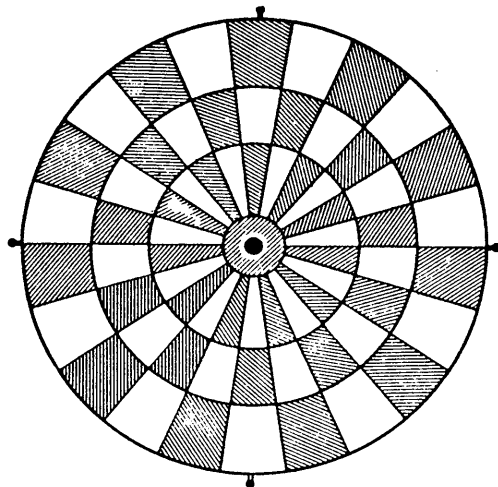

LIGHTING

MARKING

A - More than 150 ft. but not more than 300 ft.

A and B - 15 ft. or more

B - Not more than 150 ft.

LIGHTING

MARKING

A and B - Not more than 150 ft.

A - 5 ft. or more
B - Less than 15 ft.

PAINTING AND LIGHTING OF GAS HOLDERS AND SIMILAR OBSTRUCTIONS

1 Jan 72

AC 70/7460-1A
Appendix i

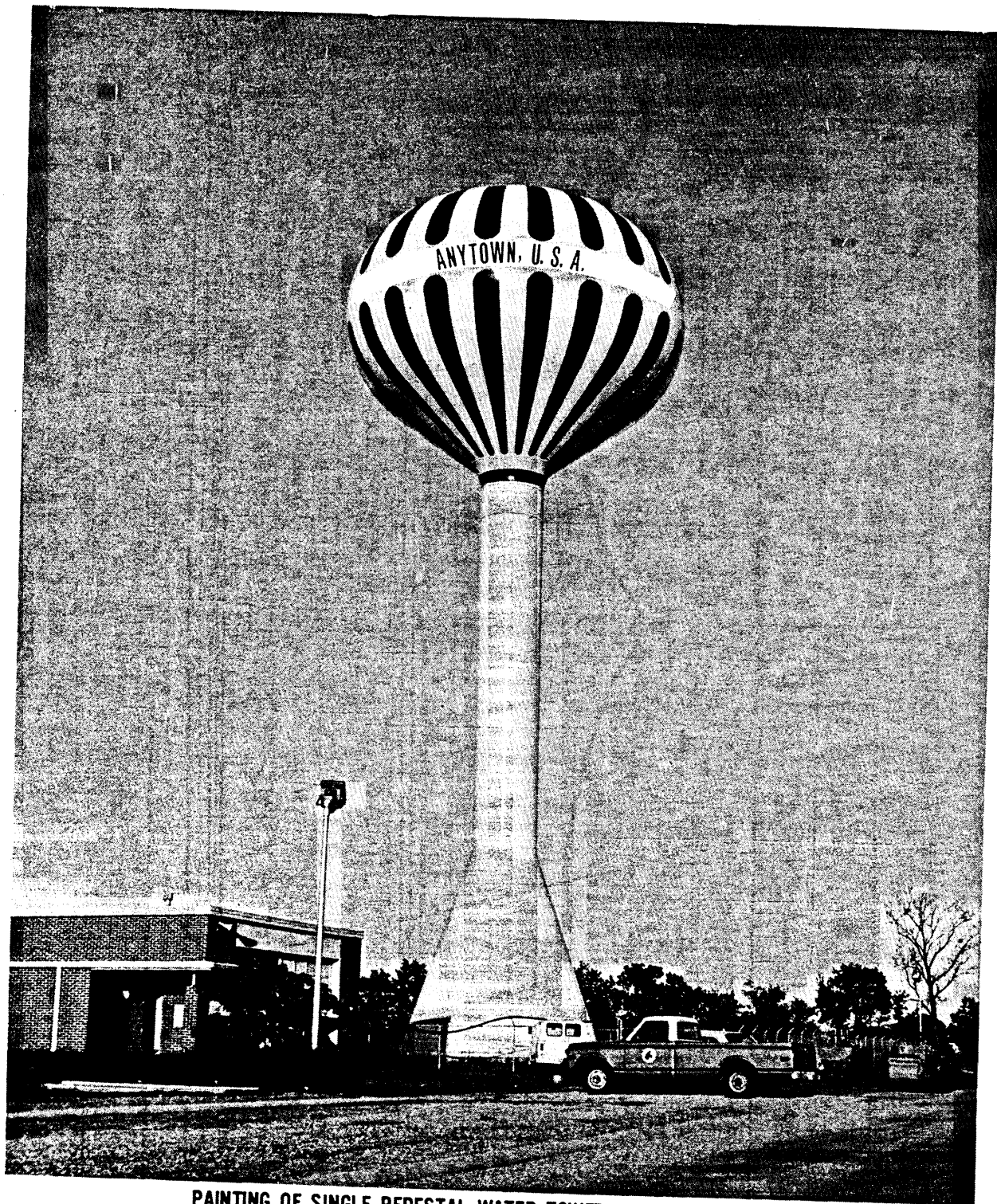

PAINING OF SINGLE PEDESTAL WATER TOWER BY BEACHBALL PATTERN

1 Jan 72

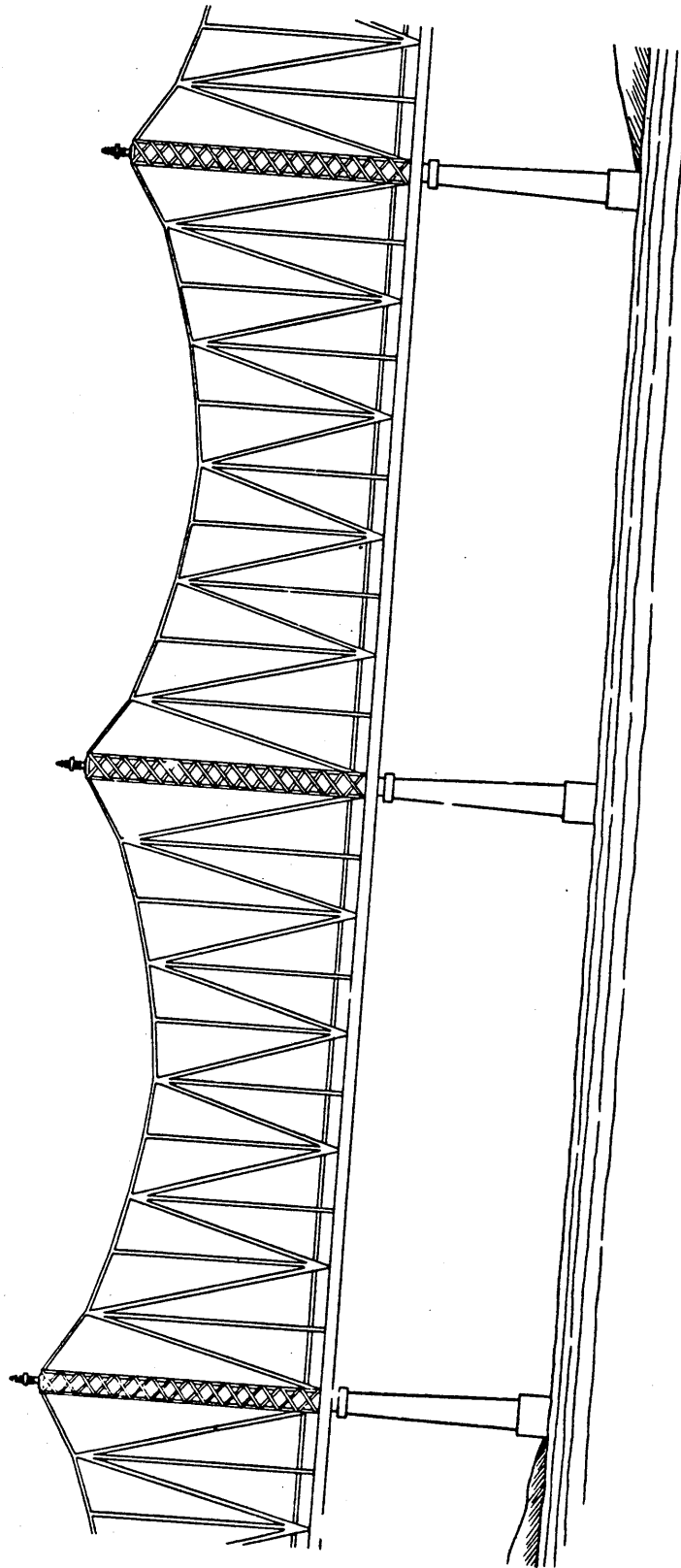

BRIDGE

1 Jan 72

AC 70/7460-1A
Appendix i

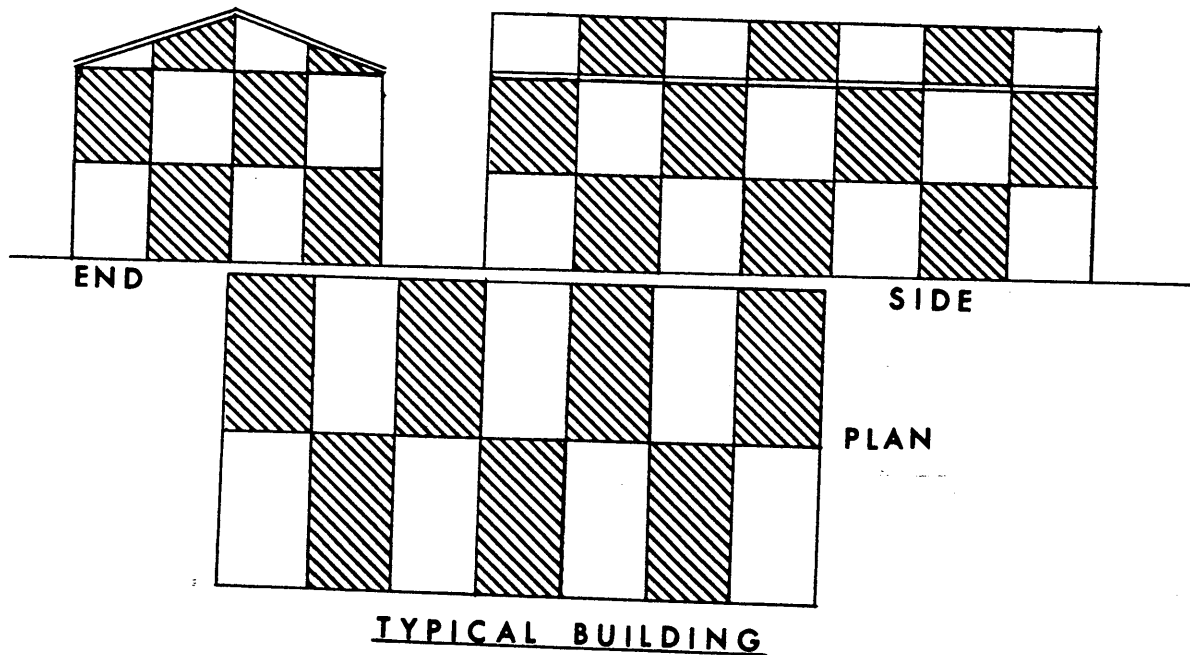
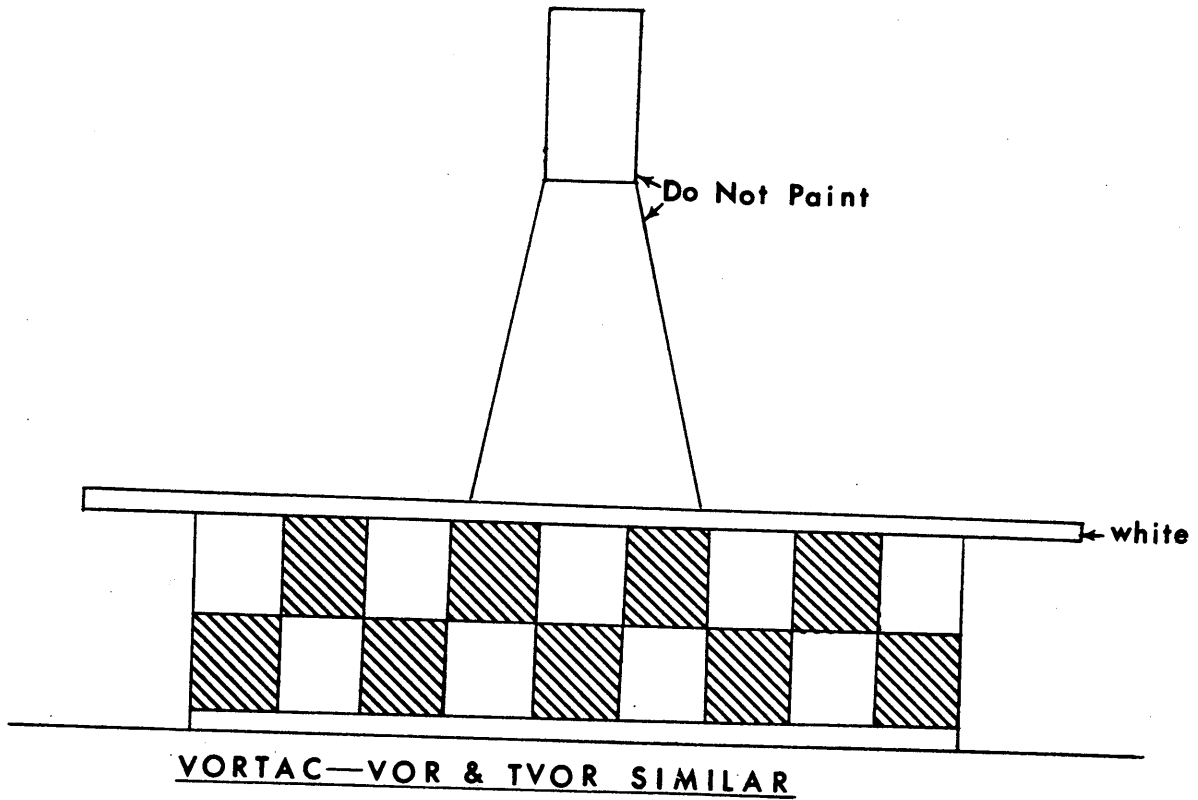

1 Jan 72

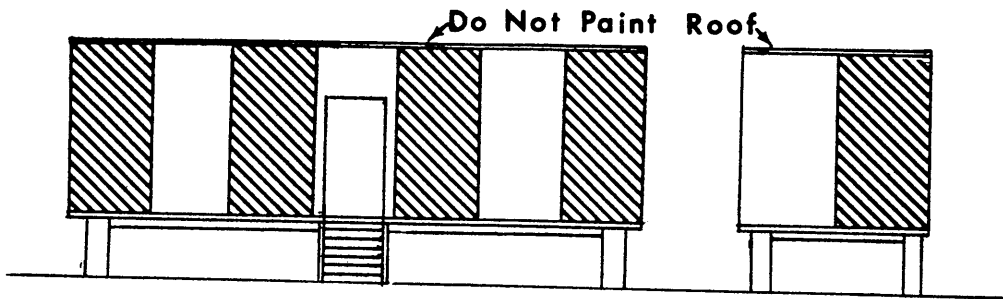

TRAILER (Mark as shown)

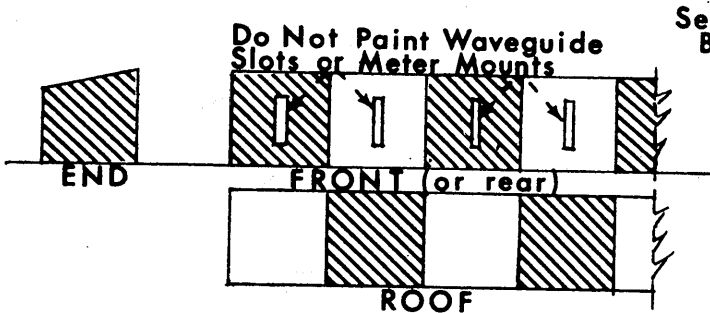

DIRECTIONAL LOCALIZER WAVEGUIDE SHELTER

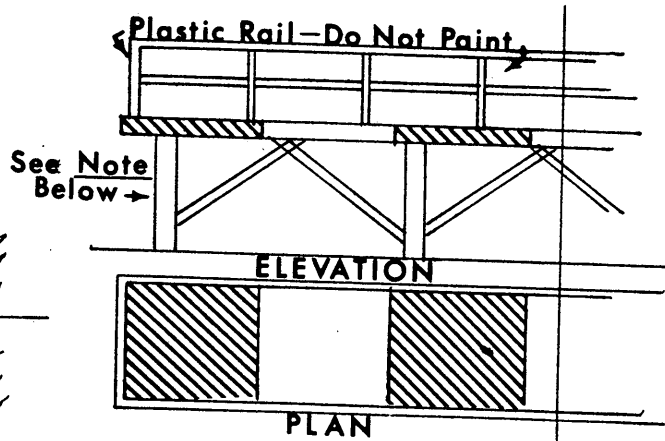

LOCALIZER ANTENNA SUPPORT

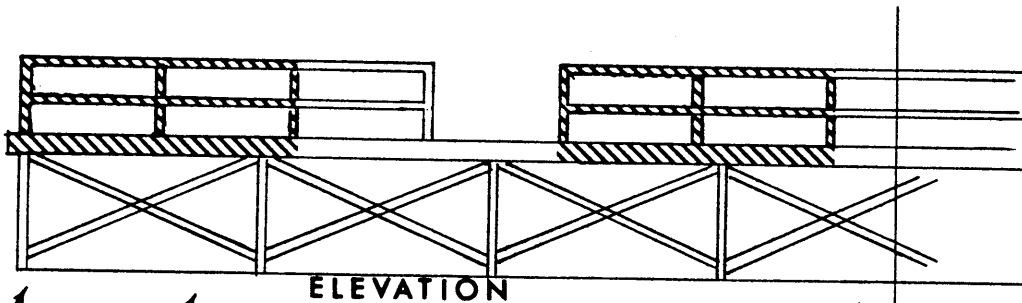

ELEVATION

Note: Supports up to 15' high paint white. Over 15' paint three equal horizontal bands, middle band white, others aviation surface orange.

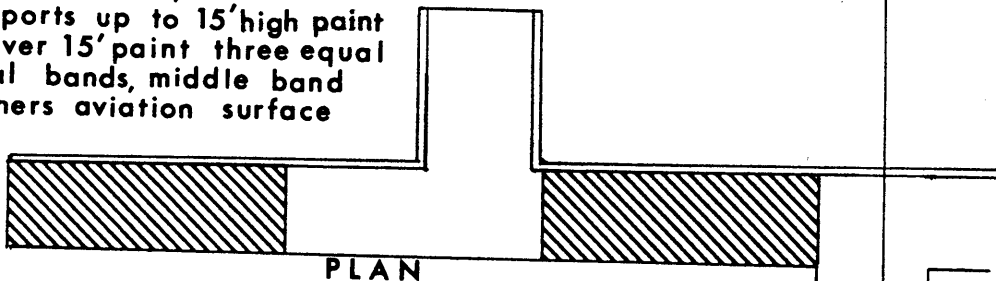

PLAN

"V"-RING ANTENNA ARRAY PLATFORM

1 Jan 72

AC 70/7460-1A
Appendix 1

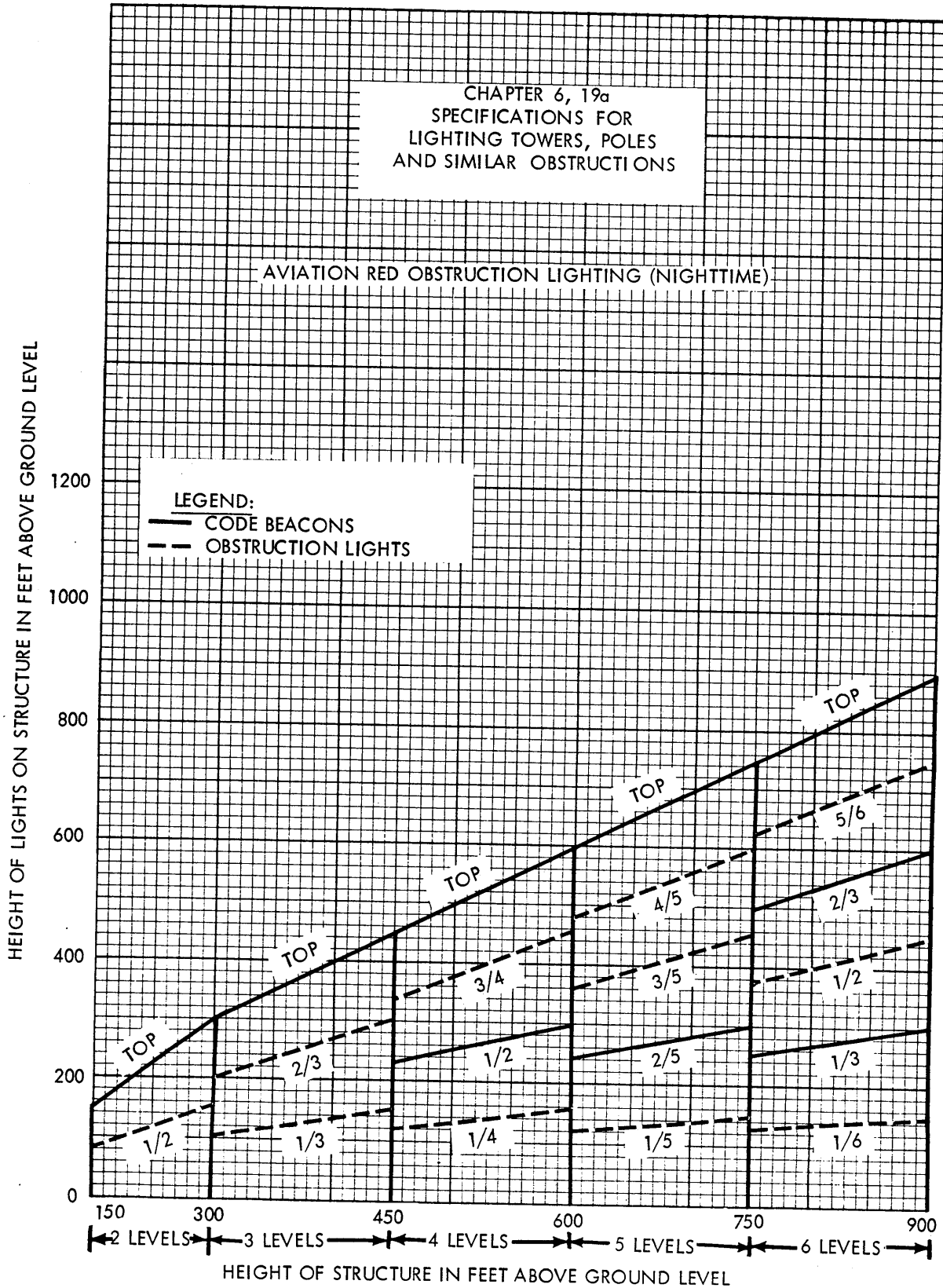

1 Jan 72

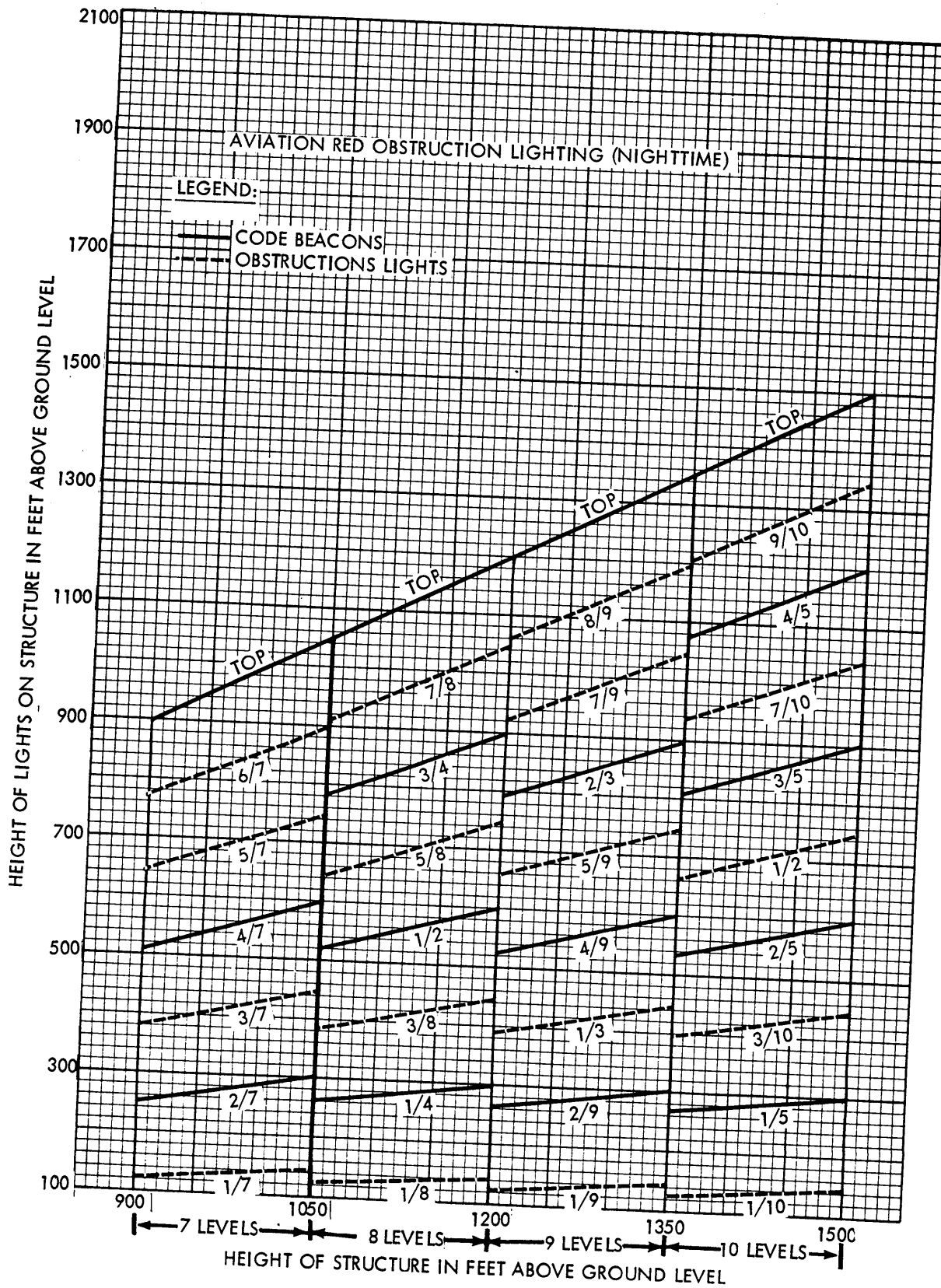

1 Jan 72

AC 70/7460-1A
Appendix i

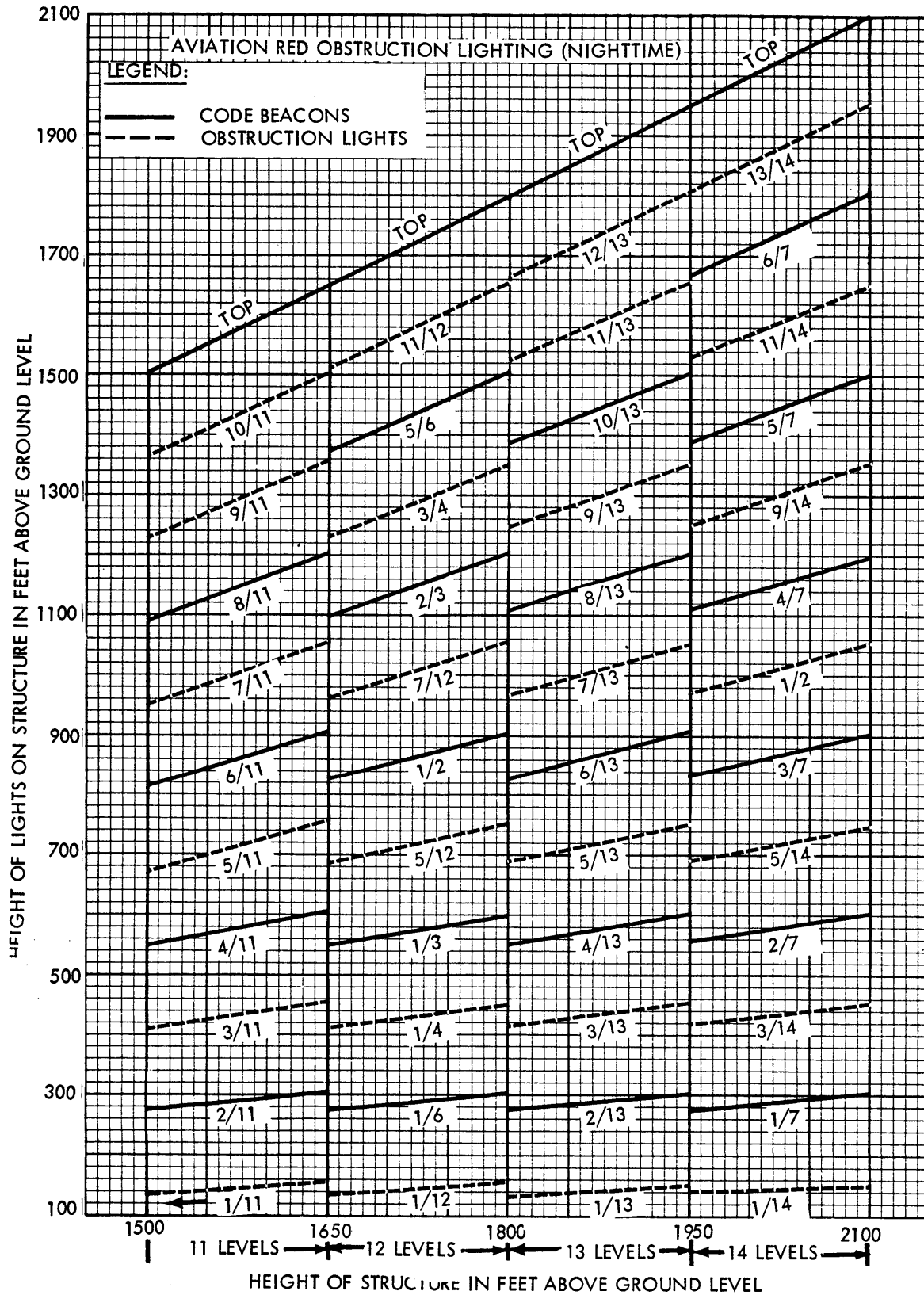

1 Jan 72

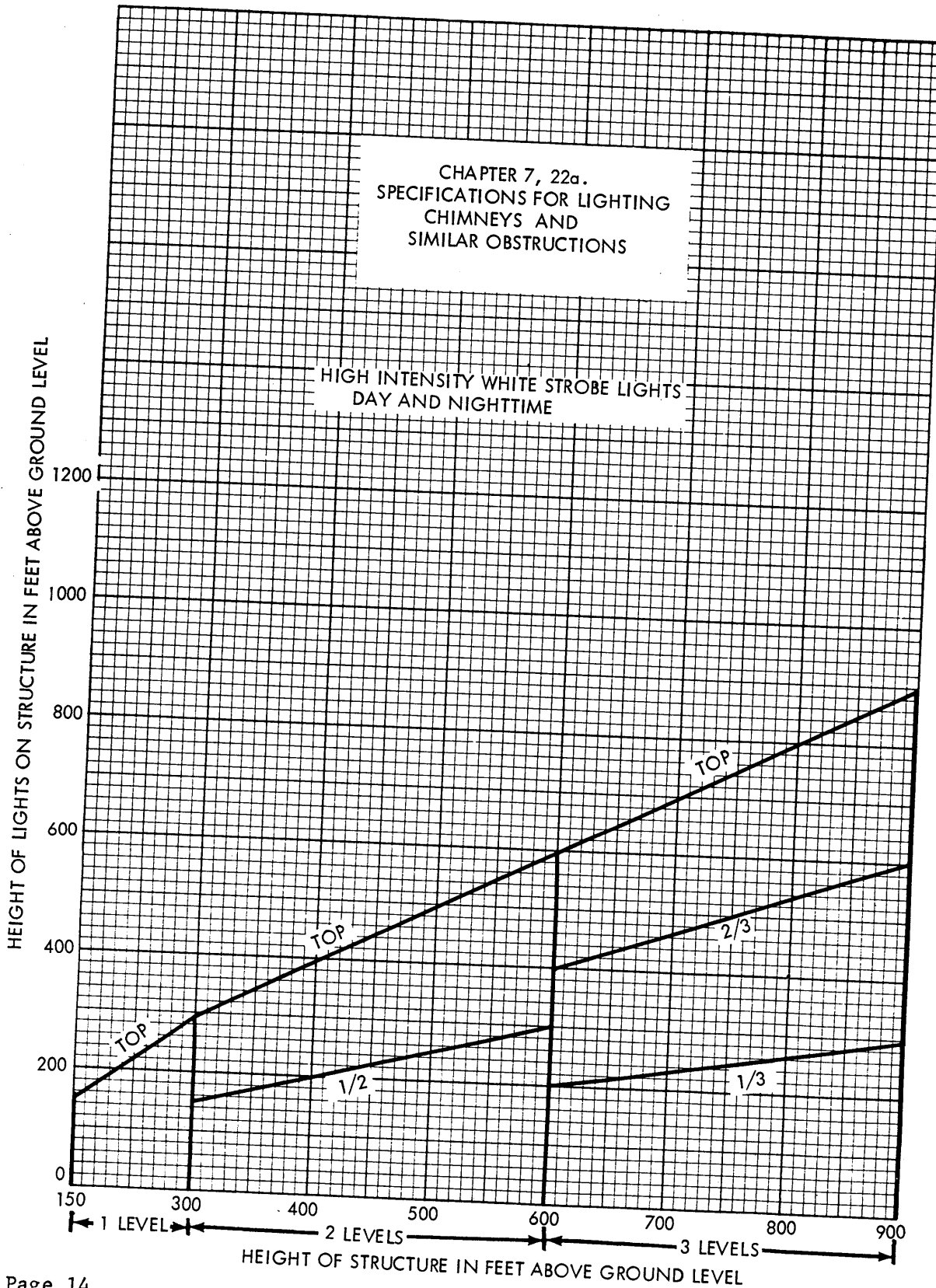

1 Jan 72

AC 70/7460-1A
Appendix i

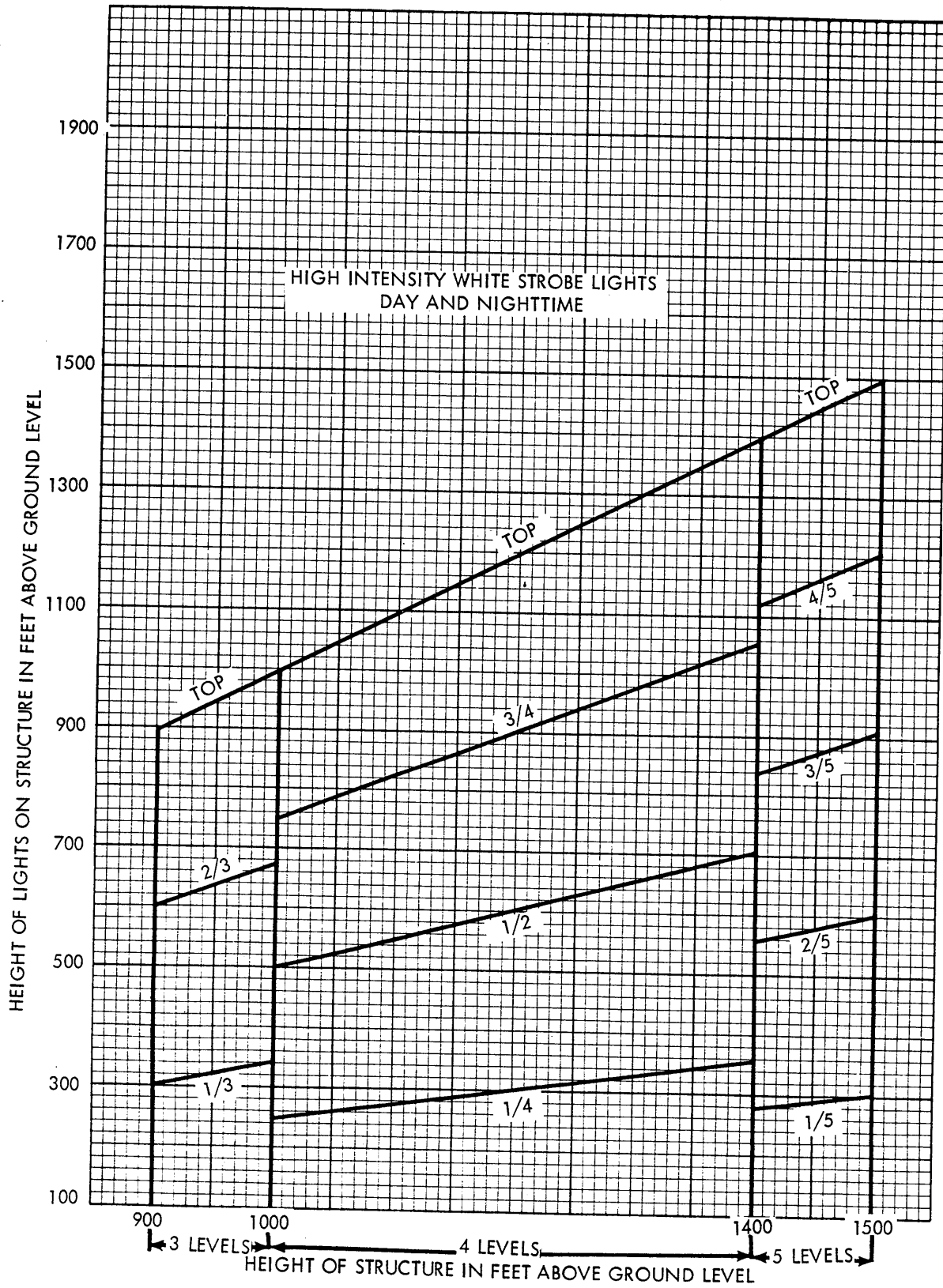

1 Jan 72

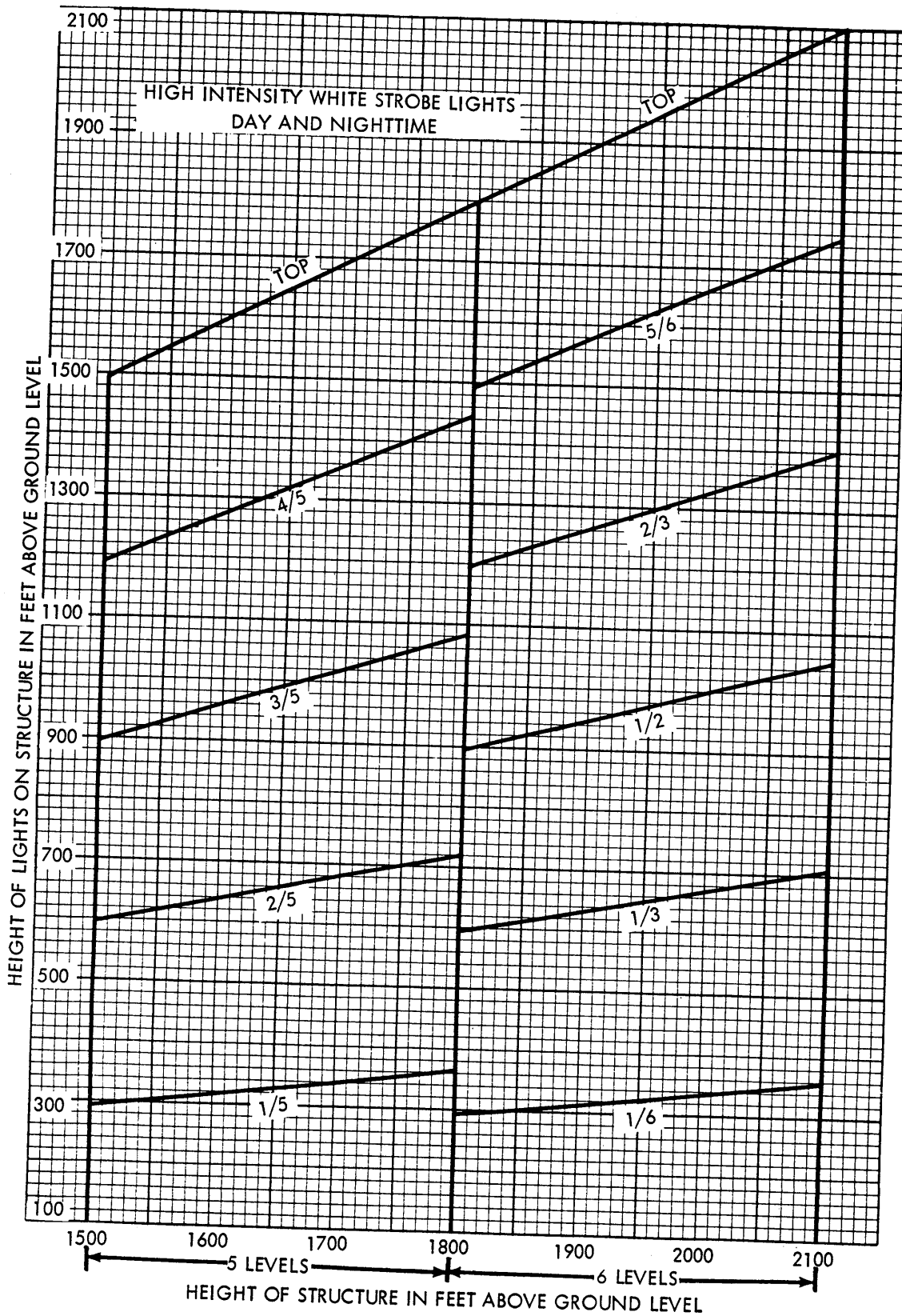

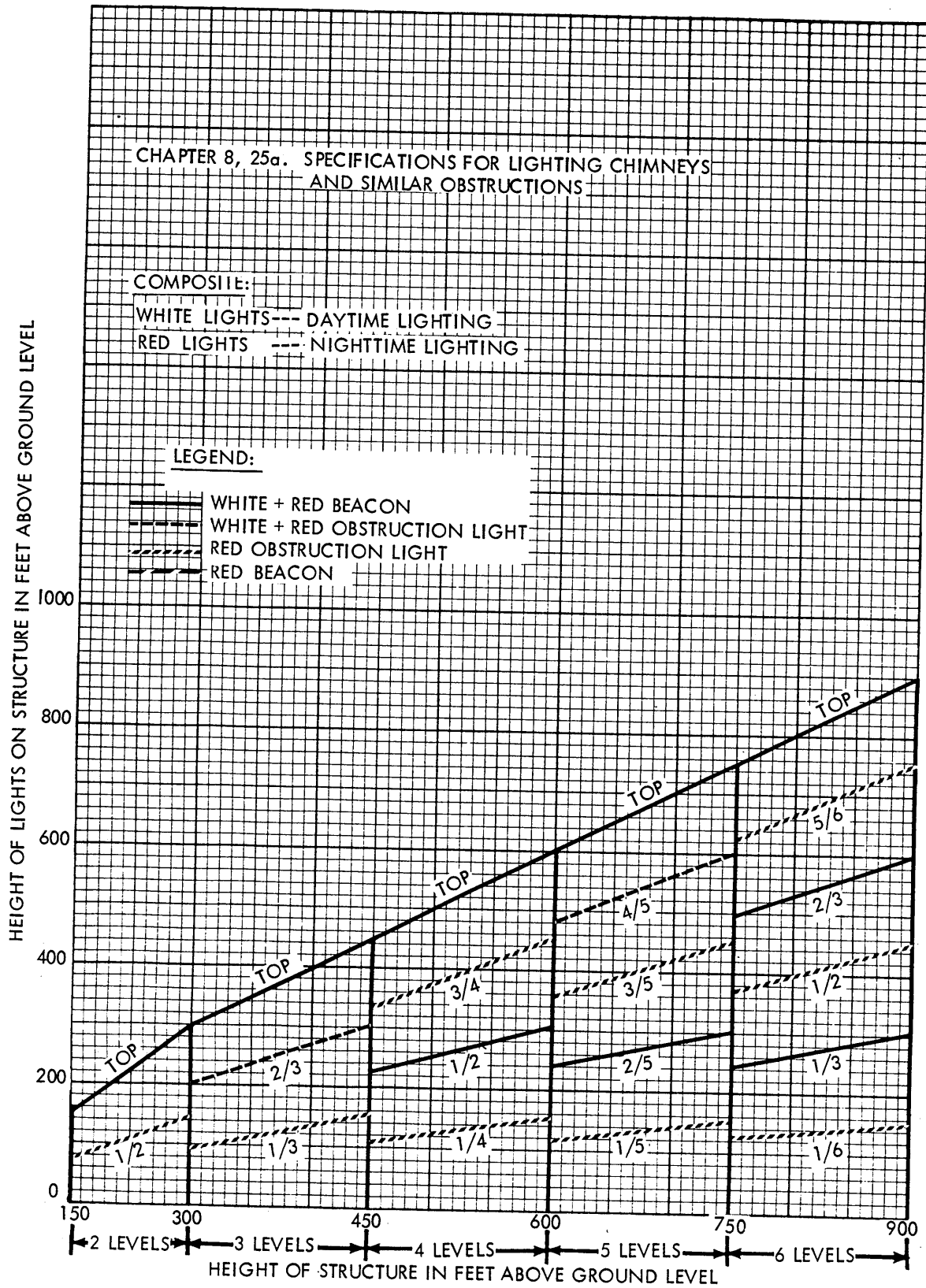

1 Jan 72

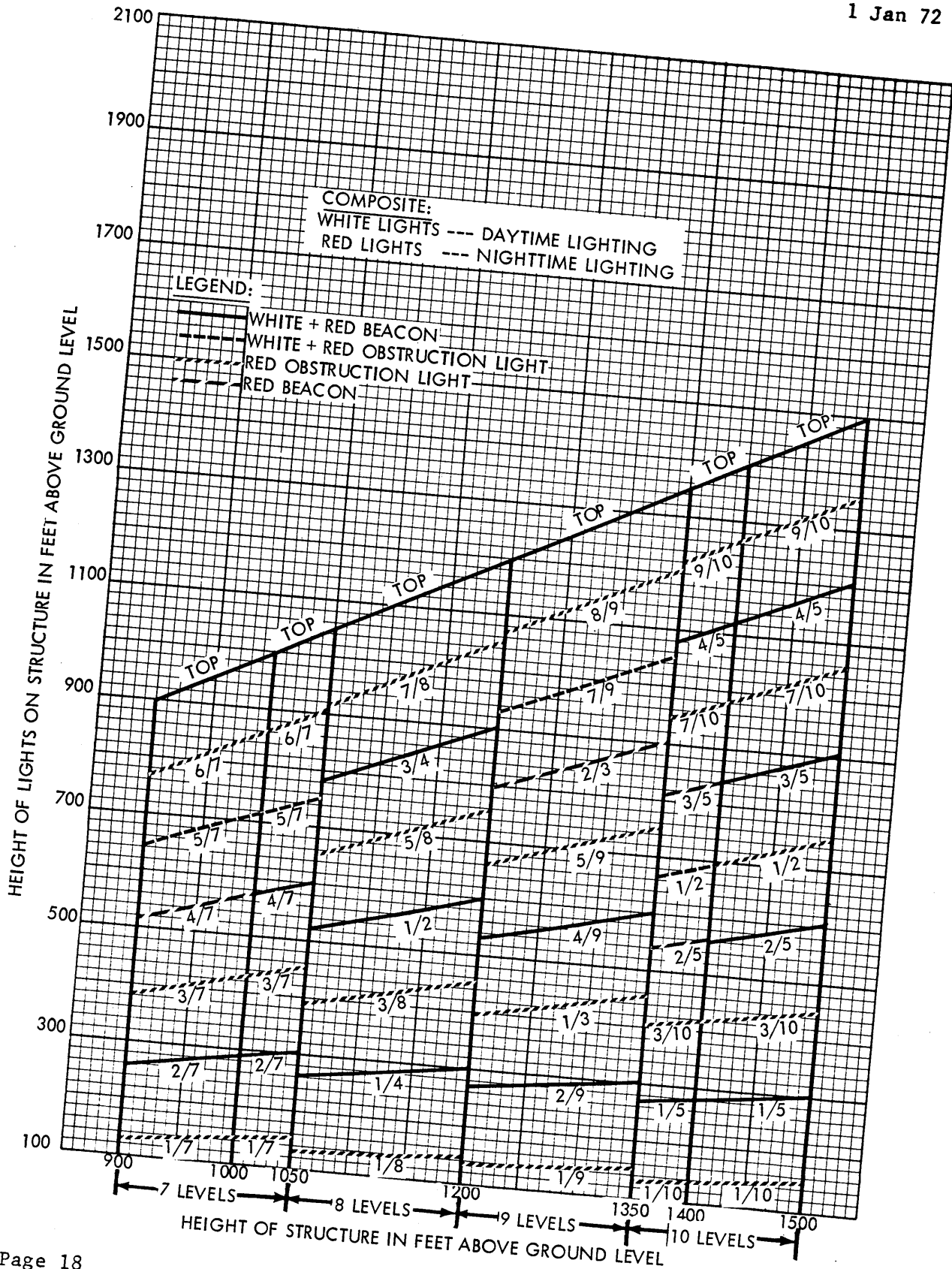

1 Jan 72

AC 70/7460-1A
Appendix 1

